

W e . s u p p o r t . t h e  
i n n o v a t i o n s . o f . c u s t o m e r s

# Leak - Proof Flow & Control Solution Partner

The Best Partner  
for Value Creation

**S-LOK®** Tube Fittings

**HanSun**

한선엔지니어링(주)  
HANSUN ENGINEERING CO., LTD.



**S-LOK**® Tube Fittings have been designed specifically for the many demanding applications such as chemical, petroleum, power generating, pulp, paper and various types of manufacturing industries. They provide a highly reliable, leak proof and torque free seal on all tubing connections. **S-LOK**® Tube Fittings are commonly used on instrumentation, process and control systems, where high quality tube fittings are required.





## Certificate List



GOOD DESIGN

Good design



N



NPT



NS



API Spec. Q1



API Monogram



API ISO/TS 29001



KS



ABS



Lloyd's



DNV

## INTRODUCTION OF S-LOK TUBE FITTING

S-LOK tube fittings are manufactured under very strict quality control to assure maximum reliable performance. S-LOK tube fittings require no special tools assembly. Connections can be quickly and easily made by simple insertion and tightening the nuts.

S-LOK tube fitting has been specifically designed for use on instrumentation, process and control systems and equipment employed in chemical, petroleum, power generating and pulp and paper plants. S-LOK tube fittings could also be used in extensive applications of other fields where very high quality tube fittings are required.

## CONSTRUCTION OF S-LOK TUBE FITTINGS

S-LOK tube fittings are composed of four precision parts; body, nut, front ferrule and back ferrule.

By screwing the nut onto the body, the nut is tightened against the tapered area of the body and its edge is compressed tightly against the tube by curling inward. The back ferrule is also located between the body and nut. As the front ferrule rolls, the back ferrule rolls up and bites into the tube resulting in the connection of tube and the fitting as well as a non-leakage effect.

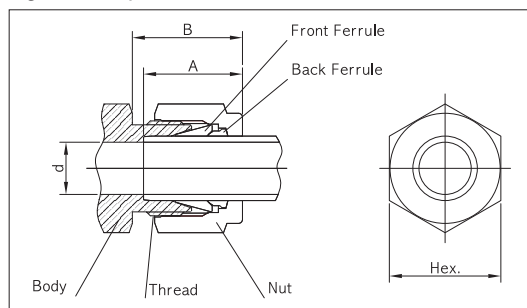

The twin ferrule design achieves the leak proof sealing by assembly motion being transmitted axially through the tubing. This results in no radial movement of the tubing upon assembly. Therefore, the tube is not stressed and the mechanical integrity is maintained. This is the result of close tolerance control in machining, surface smoothness and hardness of each and every part of S-LOK tube fittings. Through this swaging action, S-LOK tube fittings are mechanically integrated with the tube connected.

S-LOK Fractional Tube End Dimensions Unit:mm

Size No.	Tube O.D	S-LOK Thread	A	B	d	Hex.
2	1/8	5/16-20UN	12.70	15.24	2.28	11.10
3	3/16	3/8-20UN	13.70	16.00	3.04	12.70
4	1/4	7/16-20UNF	15.24	17.78	4.80	14.20
5	5/16	1/2-20UNF	16.25	18.54	6.35	15.80
6	3/8	9/16-20UN	16.76	19.30	7.10	17.40
8	1/2	3/4-20UNEF	22.86	21.84	10.40	22.20
10	5/8	7/8-20UNEF	24.38	21.84	12.70	25.40
12	3/4	1-20UNEF	24.38	21.84	15.70	28.60
14	7/8	1-1/8-20UN	25.90	21.84	18.20	31.80
16	1	1-5/16-20UN	31.24	26.41	22.40	38.10

S-LOK Metric Tube End Dimensions Unit:mm

Size No.	Tube O.D	S-LOK Thread	A	B	d	Hex.
3M	3mm	5/16-20UN	12.9	15.3	2.4	12.0
4M	4mm	3/8-20UN	13.7	16.1	2.4	12.0
6M	6mm	7/16-20UNF	15.3	17.7	4.8	14.0
8M	8mm	1/2-20UNF	16.2	18.6	6.4	16.0
10M	10mm	5/8-20UN	17.2	19.5	7.9	19.0
12M	12mm	3/4-20UNEF	22.8	22.0	9.5	22.0
15M	15mm	7/8-20UNEF	24.4	22.0	11.9	25.0
16M	16mm	7/8-20UNEF	24.4	22.0	12.7	25.0
18M	18mm	1-20UNEF	24.4	22.0	15.1	30.0
20M	20mm	1-1/8-20UN	26.0	22.0	15.9	32.0
22M	22mm	1-1/8-20UN	26.0	22.0	18.3	32.0
25M	25mm	1-5/16-20UN	31.3	26.5	21.8	38.0

## FITTING MATERIALS

S-LOK tube fittings are made of stainless steel (usually SS316), brass and alloy steel (Monel or others).

## SUITABLE TUBING MATERIALS

S-LOK tube fittings can be used with the following tube specifications.

Stainless steel tube;

- TP304 and TP316 of ASTM A269 or A213, or equivalent.
- SUS304TP and SUS316TP of JIS G3459 or equivalent.
- The wall thickness selection should be based on the operation pressure, temperature and shock conditions. Fully annealed tubing is recommended.

Stainless steel tubing having a hardness of Rockwell B80 or less should be used.

- Specific recommendation-See Table 1.(page 5)

## Typical Raw Material List

Fitting Material	Bar Stock	Forging	Tubing
Stainless Steel Type 316	ASTM A479 ASTM A276 JIS G4303	ASTM A182 F316 JIS G3214	ASTM A269 ASTM A213 ASTM A249
Brass	ASTM B16 Alloy 360 ASTM B453 Alloy 345 JIS H3250 Alloy C3604	ASTM B124 Alloy 377 JIS H3250 Alloy C3771	ASTM B68 ASTM B75 ASM B88 DIN 1786
Carbon Steel	JIS G4051 S20C-S48C	JIS G4051 S20C-S48C	ASTM A161 ASTM A179 DIN 2391
Alloy 400	ASTM B164	ASTM B164	ASTM B165

**Tubing**

Suitable tubing selection is essential in performance of tubing system. For safe, reliable and leak-free seals tubing should be considered as a fitting component. S-LOK tube fittings perform best when good quality tubing is used. When selecting tubing material including size and wall thickness, customer must consider pressure, flow, temperature, environment and compatibility of system.

- General Rules.

1. For leak-free sealing, the tubing surface is very important. The tubing must have a good surface free from scratches, draw mark, flat spots or dirt.
2. In case of welded tubing, it should not have a visible poor bead on its outside diameter.
3. Tubing and fitting material is essential for the thermal compatibility and corrosion resistance. The tubing and material should be compatible with the process fluid, temperature and environment.
4. Tubing must be softer than fitting material. When tubing and fittings are made of the same material, the metal tubing must be fully annealed.
5. Tubing hardness must be selected according to the information in the table 2 to 4.
6. Do not select a too thin or too thick wall. A too thin wall may collapse and a too thick wall may not properly be deformed by the ferrule action. The wall thickness selection should be based on the applicable pressure, temperature, shock and vibration.

- Consideration facts at the selection of tube.

1. Quality of the tube material and manufacturing method.
2. Hardness of tube.
3. Surface treatment of tube.
4. O.D and tolerance.
5. Wall thickness and tolerance.
6. Concentricity of tube.
7. Ovality. (Shape)

**Tubing Temperature Ratings**

The maximum and minimum operating temperatures for various tubing material.

Tubing Material	Temperature Range
Stainless Steel 316	-321°F to 1200°F (-196°C to 649°C)
Carbon Steel	-65°F to 799°F (-53°C to 426°C)
Copper	-40°F to 400°F (-40°C to 205°C)
Alloy 400	-324°F to 800°F (-198°C to 427°C)
Alloy C276	-320°F to 1000°F (-195°C to 537°C)
Alloy 600	-205°F to 1200°F (-130°C to 648°C)
Titanium	-320°F to 600°F (-195°C to 315°C)
Teflon	0°F to 150°F (-17°C to 65°C)

**Allowable working temperature**

When Elastomer seal is used in the fitting, care must be taken for allowable working temperature. See working temperature below.

Elastomer seal material	Working Temperature
NBR (e. g. perbunan <sup>®</sup> )	-40°C to 110°C (-40°F to 230°F)
FKM (e. g. Viton <sup>®</sup> )	-28°C to 204°C (-20°F to 400°F)
PTFE (e. g. Teflon <sup>®</sup> )	-60°C to 204°C (-76°F to 464°F)

**Temperature De-rating Factors**

The allowable working pressure is determined by various temperatures.

To determine the working pressure at the specific temperatures, multiply the working pressure at ambient temperature shown in table 2-4 by the factor shown in table 1.

Table 1. Temperature De-rating Factors

Temp. °F (°C)	Stainless Steel ASTM A269		C.Steel ASTM A179	Copper ASTM B75	Alloy 400
	304	316			
100 (37)	1.00	1.00	1.00	1.00	1.00
200 (93)	1.00	1.00	0.95	0.80	0.88
300 (148)	1.00	1.00	0.90	0.78	0.82
400 (204)	0.93	0.96	0.86	0.50	0.79
500 (206)	0.87	0.90	0.82	0.13	0.79
600 (315)	0.82	0.85	0.77	-	0.79
700 (370)	0.80	0.82	0.73	-	0.76
800 (426)	0.76	0.79	0.59	-	0.76
900 (480)	0.73	0.78	-	-	-
1000 (537)	0.69	0.76	-	-	-
1200 (649)	0.30	0.37	-	-	-

Example: Tube SS316 3/8 O.D. x 0.035" at 700°F.  
 $3.300\text{psi} \times 0.82 = 2.706\text{psi}$   
 Therefore 2.706psi is the maximum allowable working pressure of SS316 3/8" O.D x 0.035" wall tubing.

## Stainless steel Tubing :

Fully annealed 304 or 316 high quality seamless steel tube to ASTM A269 or equivalent.

Hardness : Rb80 or less

Table 2. Stainless steel Tubing

Stainless Steel Fractional Tubing																				
Tube O.D (inches)	Tube Wall Thickness in Inches																			
	0.010	0.012	0.014	0.016	0.020	0.028	0.035	0.049	0.065	0.083	0.095	0.109	0.120	0.134	0.156	0.188				
1/16"	5,600	6,800	8,100	9,400	12,000															
1/8"						8,500	10,900					Working Pressure in psig								
3/16"						5,400	7,000	10,200												
1/4"						4,000	5,100	7,500	10,200											
5/16"									4,000	5,800	8,000									
3/8"									3,300	4,800	6,500									
1/2"	For gas service, applying						2,600	3,700	5,100	6,700										
5/8"	tube wall thickness only									2,900	4,000	5,200	6,000							
3/4"	on outside of shade boundary									2,400	3,300	4,200	4,900	5,800						
7/8"										2,000	2,800	3,600	4,200	4,800						
1"												2,400	3,100	3,600	4,200	4,700				
1 1/4"												2,400	2,800	3,300	3,600	4,100	4,900			
1 1/2"														2,300	2,700	3,000	3,400	4,000	4,900	
2"																2,000	2,200	2,500	2,900	3,600

Stainless Steel Metric Tubing																
Tube O.D (mm)	Tube Wall Thickness in Inches															
	0.71 (0.028)	0.89 (0.035)	1.00	1.25 (0.049)	1.50	1.65 (0.065)	2.0	2.11 (0.083)	2.41 (0.095)	2.50	2.77 (0.109)	3.00	3.05 (0.120)	3.50	4.00	4.50
3	10,800	13,800	15,300									Working Pressure in psig				
4	7,900	10,100	11,500	14,400												
6	5,000	6,500	7,400	9,400	11,500	12,700										
8		4,700	5,800	6,800	8,400	9,300										
10		3,700	4,200	5,300	6,500	7,300										
12		3,000	3,400	4,400	5,300	5,900	6,600	7,000								
16				2,500	3,200	3,900	4,300	5,300	5,700	6,600	6,800					
18					2,800	3,400	3,800	4,700	5,000	5,800	6,000	6,700				
20	For gas service,			2,500	3,000	3,400	4,200	4,400	5,100	5,300	6,000					
22	applying tube wall			2,300	2,800	3,000	3,800	4,000	4,600	4,800	5,400					
25	thickness only on			2,000	2,400	2,700	3,300	3,500	4,000	4,200	4,700	5,100	5,200			
38	outside of shade boundary									2,300	-	2,900	-	3,400	3,900	4,400

- Working pressures are based on allowable stress value of 20,000psi (137,800kPa=1,378bar) as specified by ASME B31.3-1999 over the temperature range of -29°C to 37°C (-20°F to 100°F).
- Safety Factor=3.75:1, considering ultimate tensile strength 75,000psi (516,700kPa=5,167bar)
- Pressure calculations are based on Maximum O.D. and minimum wall thickness and no allowance is made for corrosion and erosion. e.g. ASTM A269 1/2 O.D x 0.035" OD tolerance ± 0.005", W.T. ± 10%. Calculations are based on 0.050" OD x 0.035" W.T.
- To determine bar, Multiply psig by 0.0689. To determine kPa, multiply psig 6.89.
- To convert bar to psig, multiply bar by 14.51
- For working pressure per ASME B31.1, multiply value by 0.94

## Welded stainless steel Tubing

Based on ASME B31.3-1999 for weld integrity a de-rating factor must be applied to welded tubing.  
 For double butt seam tubing multiply by 0.85  
 For single butt seam tubing multiply by 0.80.

**Copper tubing :**

High quality soft annealed seamless copper tube to ASTM B-75 or equivalent.  
 Hardness : Rockwell 15T 60 or less

Table3. Copper Tubing

Copper Fractional Tubing										
Tube O.D. (inches)	Tube Wall Thickness in Inches									
	0.010	0.012	0.028	0.035	0.049	0.065	0.083	0.095	0.109	0.120
1/16"	1,700	3,800	5,400	6,000						
1/8"			2,700	3,400						
3/16"			1,800	2,300	3,400					
1/4"			1,300	1,600	2,500	3,500				
5/16"				1,300	1,900	2,700				
3/8"				1,000	1,600	2,200				
1/2"	For gas service, applying			800	1,100	1,600	2,200			
5/8"	tube wall thickness only on				900	1,200	1,600	1,900		
3/4"	outside of shade boundary				700	1,000	1,300	1,500	1,800	
7/8"					600	800	1,100	1,300	1,500	
1"					500	700	900	1,100	1,300	1,500

Copper Metric Tubing													
Tube O.D. (mm)	Tube Wall Thickness in Millimeters(inches)												
	0.71 (0.028)	0.89 (0.035)	1.0	1.25 (0.049)	1.5	1.65 (0.065)	2.0	2.11 (0.083)	2.41 (0.095)	2.5	2.77 (0.109)	3.0	3.05 (0.120)
3	3,465	4,400	4,900										
4	2,520	3,230	3,670	4,610									
6	1,6110	2,070	2,350	3,020	3,670	4,060							
8		1,510	1,710	2,790	2,680	2,990							
10		1,190	1,350	1,710	2,090	2,320							
12		970	1,100	1,410	1,710	1,900	2,350	2,500					
16			810	1,030	1,260	1,390	1,710	1,810	2,100	2,190			
18	For gas service,			915	1,100	1,220	1,510	1,600	1,840	1,930	2,160		
20	applying tube wall			810	990	1,090	1,350	1,420	1,650	1,710	1,920		
22	thickness only on outside			740	900	990	1,200	1,290	1,480	1,550	1,730		
25	of shade boundary			640	780	870	1,060	1,120	1,290	1,350	1,490	1,640	1,670

- Working pressures are based on allowable stress value of 6000psi(413bar=41,300kPa) as specified by ASME B31.3-1999 over the temperature range of -29°C to 37°C (-20°F to 100°F).
- Safety Factor=5:1, considering ultimate tensile strength 30,000psi (2067bar=206,700kPa)
- Pressure calculations are based on Maximum O.D. and minimum wall thickness and no allowance is made for corrosion and erosion.
- For working pressure per ASME B31.1, multiply value by 0.94

### Alloy 400 Tubing

Fully annealed seamless Alloy 400 tubing to ASTM B165 or equivalent.  
Hardness : Rb75 or less

Table 4. For seamless Alloy400 Tubing

Tube O.D. (inches)	Tube Wall Thickness in Inches									
	0.010	0.012	0.028	0.035	0.049	0.065	0.083	0.095	0.109	0.120
1/8"			7,900	10,100						
1/4"			3,700	4,800	7,000	9,500				
3/8"				3,100	4,400	6,100		Working Presssure in psig		
1/2"				2,300	3,200	4,400				
3/4"					2,200	3,000	4,000	4,600		
1"						2,200	2,900	3,400	3,900	4,300

- Working pressures are based on allowable stress value of 18,700psi (128,000kPa=1288bar) as specified by ASME B31.3-1999 over the temperature range of -29°C to 37°C (-20°F to 100°F).
- Safety factor=3.75:1, considering ultimate tensile strength 70,000psi (482,300kPa=4,823bar)
- Pressure calculations are based on maximum O.D. and minimum wall thickness and no allowance is made for corrosion and erosion.
- For working pressure per ASME B31.1, multiply value by 0.94

### Special Alloy Tubing

When special alloy tubing is selected, we recommend:

Fully annealed seamless (or welded and cold-drawn, where permitted) alloy tubing to the ASTM specification as shown below. Tubing should be free of scratches for bending or flaring.

S-LOK material Designator	Tube Material	ASTM Number	Tubing	
			Type	Maximum hardness
HC	Alloy C276	B622	Seamless	RB 90
In	Alloy 600	B167	Seamless	RB 90
Ti	Titanium-Grade2	B338	Seamless or Welded	RB 90

#### Pressure Rating Equivalents:

- |                              |  |
|------------------------------|--|
| 1) 1bar = 100kPa = 14.51psi  | 2) 1kPa = 0.01bar = 0.1451 psi               |
| 3) 1psi = 0.069bar = 6.89kPa | 4) 1 kg/cm <sup>2</sup> = 0.98bar = 14.22psi |

### Tubing for Gas application

S-LOK tube fittings are designed for a wide range of leak-free application including gas leak proof and vacuum service. Gases can escape even the most minute leakpath due to their small molecules. Tube must therefore be carefully handled not to get scratched.

Use heavier wall tubing for gas service. Heavy wall tubing resists ferrule action by coining out minor defects of the tube surface and thin wall tubes may collapse with little resistance to ferrule action.

For gas service, use the tubing of the un-shadowed section in table 2 - 4

### Cryogenic Service

S-LOK fittings in S316 stainless steel provide highly reliable performance from cryogenic temperatures to high temperature levels.

S316 Stainless steel temperature rating : -321°F to 1200°F (-196°C to 649°C)

Cryogenic temperature are considered to be temperatures below : -100°F (-73°C)



**Pipe Thread**

Many S-LOK tube fittings have a male or female pipe end. These ends sometimes have a lower pressure rating than the pressure rating of the tube fitting end.

Table5. Pipe End Pressure Rating

Size Designator	ISO/NPT Pipe Size	Stainless Steel 316				Brass				Carbon Steel			
		Male		Female		Male		Female		Male		Female	
		pisg	bar	pisg	bar	pisg	bar	pisg	pisg	pisg	bar	pisg	pisg
1	1/16	11,000	758	6,700	462	5,500	379	3,300	227	11,000	758	6,700	462
2	1/8	10,000	689	6,500	448	5,000	345	3,200	221	10,000	689	6,500	448
4	1/4	8,000	551	6,600	455	4,000	276	3,300	227	8,000	551	6,600	455
6	3/8	7,800	538	5,300	365	3,900	269	2,600	179	7,800	538	5,300	365
8	1/2	7,700	531	4,900	338	3,800	262	2,400	165	7,700	531	4,900	338
12	3/4	7,300	503	4,600	317	3,600	248	2,300	159	7,300	503	4,600	317
16	1	5,300	365	4,400	303	2,600	179	2,200	152	5,300	365	4,400	303
20	1-1/4	6,000	414	5,000	345	3,000	207	2,500	172	6,000	414	5,000	345
24	1-1/2	5,000	345	4,600	317	2,500	172	2,300	159	5,000	345	4,600	317
32	2	3,900	269	3,900	269	1,900	131	1,900	131	3,900	269	3,900	269

- The ratings shown above are based on ASME B31.3-1999
- Female pipe ends have lower ratings than male pipe in a given size due to the inner and outer diameters of female threads being larger than those of male pipe ends.
- The ratings shown above are reference only.

**Pipe Thread Sealant**

Pipe thread sealant is essential to ensure leak-free seal.

Since the Teflon™ tape is commonly used, we provide information of recommended tape width, as well as the numbers of thread to be wrapped. The Teflon™ tape fills the voids between threads and prevents galling on pipe threads. The sealant usually contains a lubricant.

Table 6.

Unit : inches

Nominal Pipe Size	Recommended Tape Width	Effective Thread Length (External) L*	Approx.# of Thread
1/8	1/8-1/4	0.2639	7
1/4	1/4	0.4018	7-1/4
3/8	1/4	0.4075	7-1/3
1/2	1/4-1/2	0.5337	7-1/2
3/4	1/4-1/2	0.5457	7-2/3
1	1/4-1/2	0.6828	8

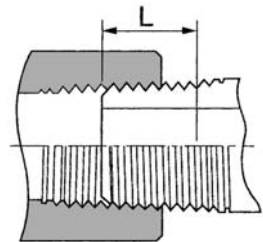

※ASME B1.20.1-NPT

**Note**

- 1.Wrap Teflon™ tape clockwise from first thread. Do not overhang the first thread, as the tape may get into the fluid system.
- 2.Teflon™ tape has a temperature limit of 230°C (450°F)

**Note**

The information shown in table 1-6 are not for design purpose, but for reference only. The accuracy of information is not the liability of our company.

## INSTALLATION INSTRUCTIONS

S-LOK is supplied finger-tight and ready for immediate use. Therefore fitting disassembly is not necessary for installation.

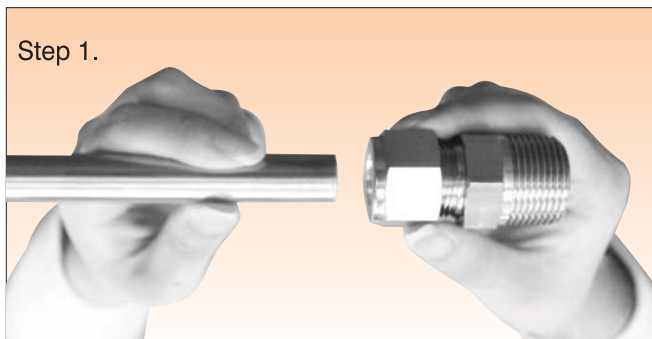

Make sure the nut is finger-tight. Put the tubing into the S-LOK tube fitting until the tube end bottoms on the shoulder inside the fitting.

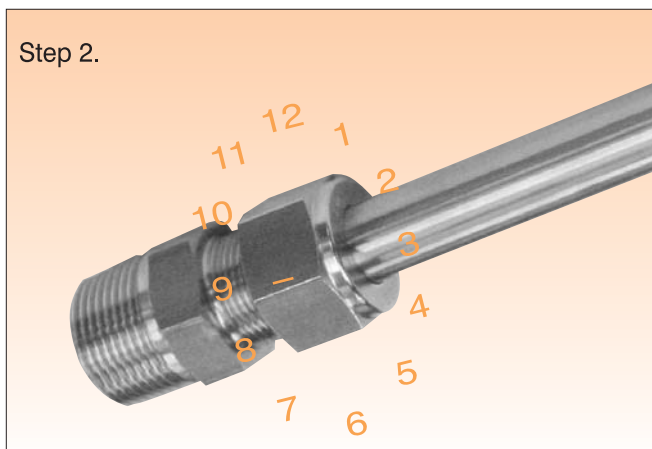

Tighten the nut 1-1/4 turn with a wrench by holding the fitting body with a back up wrench.

Marking the nut at the 9:00 o' clock position may be necessary for counting the number of turns as the mark will stop at the 12 o' clock position after 1-1/4 turns.

\*Only 3/4 turn from finger tight is required for sizes 1/8", 3/16", 3mm and 4mm.

## Re-assembly Instructions

S-LOK connections can be used many times. Prior to re-assembly, ensure the components are clean and free of defects.

### Step 1.

Insert the tubing with pre-swaged ferrules and a nut into the body until the front ferrule seats firmly in the fitting body.

### Step 2.

Hand tighten the nut. Then rotate the nut with a wrench to the original 1-1/4 tight position (sharp rise in torque is felt at the original position) and snug slightly with a wrench.

## Tube handling during installation

1. Do not force the tubing into the fitting when it does not smoothly go in. It may be a deformed oval or have burrs at the tubing end.
2. It is important to use the proper tube cutter and maintain a sharp cutting wheel on it always.

**Proper Tube Handling**

Good handling practices can greatly save the good surface finish of the tubing supplied.

- Tubing should never be dragged out of a tubing rack.
- Tubing should never be dragged across cement, asphalt, gravel or any other rough surface.
- Tubing cutter wheel and hacksaw blade should always be sharp.
- Try not to take deep cuts with each turn of the cutter or stroke of the saw.
- Tube end should always be deburred.
- Tubing should be stored to avoid collection of dirt and contamination.
- If possible, tubing ends should be plugged so any foreign materials will not fall inside.

**Tube bending**

For leak tight installation, In case of bending tubing near at S-LOK fittings, there should be enough lineal distance from bending point to the fittings. When tube bend is too close to a fitting, the deformed section at bend shall enter the fitting and it may result in leaks. Also, the bending radius should not be too short of bending radius may affect the working pressure and may cause insufficient flow. Minimum bending radius is usually recommended by the tube bender manufacture.

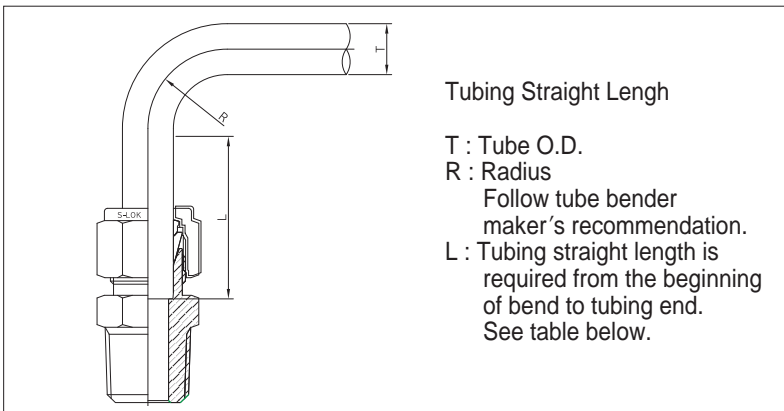

• Straight length of Fractional tubing Unit:Inch

Tube O.D	Straight Length	
	L1	L2
1/16	2/1	13/32
1/8	23/32	19/32
3/16	3/4	5/8
1/4	13/16	11/16
5/16	7/8	23/32
3/8	15/16	3/4
1/2	13/16	31/32
5/8	1-1/4	1-1/32
3/4	1-1/4	1-1/32
7/8	1-5/16	1-1/32
1	1-1/2	1-9/32
1-1/4	2	1-13/16
1-1/2	1-13/32	2-7/32
2	3-1/4	3-1/32

• Straight length of Metric tubing Unit:mm

Tube O.D	Straight Length	
	L1	L2
3	19	16
6	21	17
8	23	18
10	25	20
12	31	24
14	32	25
16	32	25
18	32	25
20	34	6
22	34	27
25	40	33
32	51	47
38	60	55

**Note**

L1=Recommended straight length of tubing required  
L2=Absolute minimum straight length of tubing required

## ORDERING INFORMATION

The symbols in the part number column on each page represent the shape and size of individual fittings.

### Example 1 : Tube to Pipe ends

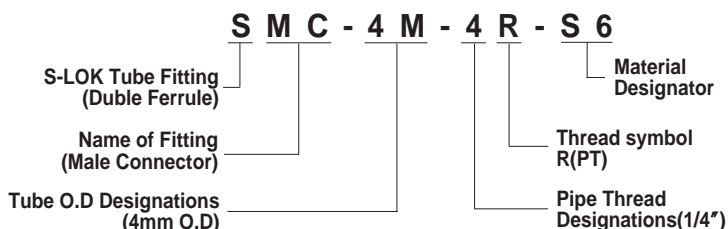

### Example 2 : Tube to Tube ends

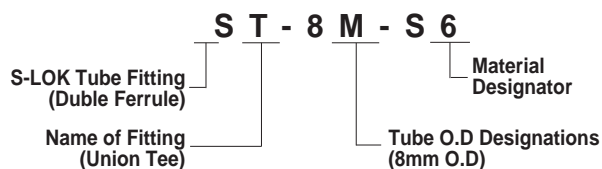

### Example 3 : Tee & Cross

Tees are described by first the run (1 and 2) and next the branch(3)

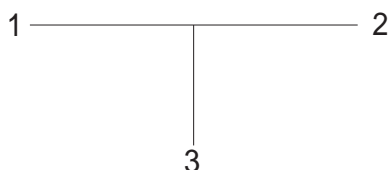

Cross are described by first the run (1 and 2) and next the branch (3 and 4)

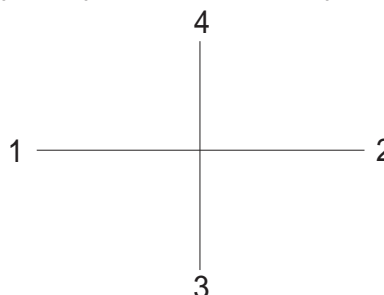

#### • Tube O.D. Designator

Inch O.D	Identifier	Metric O.D	Identifier
1/16	1	2mm	2M
1/8	2	3mm	3M
3/16	3	4mm	4M
1/4	4	6mm	6M
5/16	5	8mm	8M
3/8	6	10mm	10M
1/2	8	12mm	12M
5/8	10	16mm	16M
3/4	12	20mm	20M
1/8	14	22mm	22M
1	16	25mm	25M
1-1/4	20	28mm	28M
1-1/2	24	32mm	32M
2	32	38mm	38M

#### • Pipe Thread Size Designator

Nom. Size	Identifier
1/8 "	2
1/4 "	4
3/8 "	6
1/2 "	8
3/4 "	12
1 "	16
1-1/4 "	20
1-1/2 "	24
2 "	32







#### • Fitting Material Designator

Material	Identifier
SS316	S6
SS316L	6L
SS304	S4
Carbon Steel	CS
Brass	BS
Alloy400	MO











#### • Pipe Thread Symbol

Type	Taper Threads		Parallel Threads	
Symbol	R	N	G	U
Specification	ISO 7/1, BS21(BSPT), JIS B 0203(PT), DIN2999	ANSI B1.20.1 (NPT)	ISO228/1, BS 2779(BSPP), JIS B0202(PF)	American Standard Unified Screw Threads

*Tube to Tube Union*





Union <b>SU</b>		14
Union Elbow <b>SL</b>		15
Reducing Union <b>SUR</b>		16,17
Union Tee <b>ST</b>		18
Union Cross <b>SX</b>		19
Bulkhead Union <b>SUB</b>		20

*Tube to Male Pipe*







Male Connector <b>SMC-N</b>		21
Male Connector <b>SMC-R</b>		22
Thermocouple Connector <b>SMCT</b>		22
Male Connector for Bonded Seal <b>SMC-G</b>		23
Male Connector for Metal Gasket <b>SOM</b>		25, 26
Bulkhead Male Connector <b>SMCB</b>		27
45° Male Elbow <b>SLBM</b>		27
Male Elbow <b>SLM</b>		28, 29
Male Run Tee <b>STRM</b>		30, 31
Male Branch Tee <b>STBM</b>		32, 33

*Tube to Female Pipe*



Female Connector <b>SCF</b>		34, 35
--------------------------------	---	--------

Gauge Connector <b>SCG</b>		36
Bulkhead Female Connector <b>SCBF</b>		36
Female Elbow <b>SLF</b>		37
Female Run Tee <b>STRF</b>		38
Female Branch Tee <b>STBF</b>		39



*Stub Tube Connector*





Reducer <b>SR</b>		40, 41
Bulkhead Adapter <b>SAB</b>		42
Male Adapter <b>SAM</b>		42, 43
Female Adapter <b>SAF</b>		44
Female Adapter <b>SAG</b>		45
Port Connector <b>SCP</b>		46
Reducing Port Connector <b>SCRCP</b>		46

*Tube to AN Tube*





AN Union <b>SUA</b>		47
AN Bulkhead Union <b>SUBA</b>		47
AN Adapter <b>SAA</b>		47

*Tube to SAE O-Ring Seal*

SAE Male Connector <b>SMCS</b>		49
Positionable SAE Male Elbow <b>SLS</b>		49

Positionable 45° SAE Male Elbow <b>SLBS</b>		50
Positionable SAE Male Run Tee <b>STRS</b>		50
Positionable SAE Male Branch Tee <b>STBS</b>		50
O-Seal Straight Thread Connector <b>SCOS</b>		52
O-Seal Pipe Thread Connector <b>SCOP</b>		52





*Tube to Weld End*

Male Pipe Weld Connector <b>SCW</b>		53
Male Pipe Weld Elbow <b>SLW</b>		54
Tube Socket Weld Connector <b>SCSW</b>		54
Tube Socket Weld Elbow <b>SLSW</b>		54
Welding Bulkhead Union <b>SBUW</b>		55

*Plug and Cap*

Plug <b>SP</b>		56
Cap <b>SC</b>		56

*Spare Parts*

Tube Insert <b>SI</b>		57
Nut <b>SN</b>		57
Front Ferrule <b>SFF</b>		58
Back Ferrule <b>SFB</b>		58
Ferrule Set <b>SFS</b>		58

**Union  
SU**

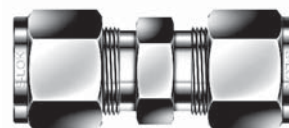
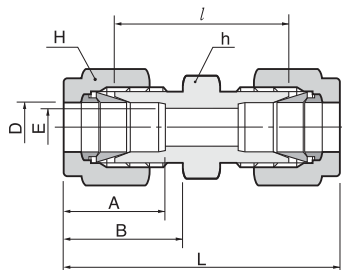

### Connects fractional tube

Part No.	Tube O.D.		E Min.	Width across flat		H	A	B	l	L
	in	mm		h	mm					
SU-1	1/16	1.59	1.27	5/16	7.93	5/16	8.63	10.92	17.50	25.15
SU-2	1/8	3.17	2.28	7/16	11.11	7/16	12.70	15.24	22.35	35.56
SU-3	3/16	4.76	3.04	7/16	11.11	1/2	13.71	16.00	24.13	37.33
SU-4	1/4	6.35	4.82	1/2	12.70	9/16	15.24	17.78	26.16	40.89
SU-5	5/16	7.93	6.35	9/16	14.28	5/8	16.25	18.54	28.19	42.92
SU-6	3/8	9.52	7.11	5/8	15.87	11/16	16.76	19.30	30.22	44.95
SU-8	1/2	12.70	10.41	13/16	20.64	7/8	22.86	21.84	30.98	51.30
SU-10	5/8	15.87	12.70	15/16	23.81	1	24.38	21.84	31.75	52.07
SU-12	3/4	19.05	15.74	1-1/16	26.98	1-1/8	24.38	21.84	33.27	53.59
SU-14	7/8	22.22	18.28	1-3/16	30.16	1-1/4	31.75	21.84	35.05	55.37
SU-16	1	25.40	22.35	1-3/8	34.92	1-1/2	38.10	26.41	40.38	64.77
SU-20	1-1/4	31.75	27.68	1-3/4	44.45	1-7/8	47.63	38.86	48.00	92.20
SU-24	1-1/2	38.10	34.03	2-1/8	53.97	2-1/4	57.15	45.21	53.60	107.95
SU-32	2	50.80	45.97	2-3/4	69.85	3	67.56	62.73	74.70	149.35

### Connects metric tube

Part No.	Tube O.D.	E Min.	Width across flat		A	B	l	L
	D		h	H				
SU-2M	2	1.7	12	12	12.9	15.3	22.4	35.6
SU-3M	3	2.4	12	12	12.9	15.3	22.1	35.3
SU-4M	4	2.4	12	12	13.7	16.1	24.1	37.3
SU-6M	6	4.8	14	14	15.3	17.7	26.2	41.0
SU-8M	8	6.4	15	16	16.2	18.6	28.2	43.2
SU-10M	10	7.9	18	19	17.2	19.5	31.0	46.2
SU-12M	12	9.5	22	22	22.8	22.0	31.0	51.2
SU-15M	15	11.9	24	25	24.4	22.0	31.8	52.0
SU-16M	16	12.7	24	25	24.4	22.0	31.8	52.0
SU-18M	18	15.1	27	30	24.4	22.0	33.3	53.5
SU-20M	20	15.9	30	32	26.0	22.0	34.8	55.0
SU-22M	22	18.3	30	32	26.0	22.0	34.8	55.0
SU-25M	25	21.8	35	38	31.3	26.5	40.4	65.0
SU-28M	28	21.8	41	46	36.6	36.6	43.4	85.0
SU-32M	32	28.6	46	50	42.0	41.6	51.3	97.3
SU-38M	38	33.7	55	60	49.4	47.9	58.4	113.6

## Union Elbow SL

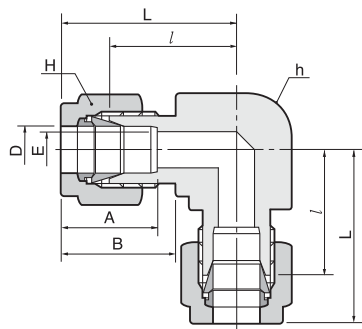

### Connects fractional tube

Part No.	Tube O.D.		E Min.	Width across flat				A	B	l	L
	D			h	H	A	B				
	in	mm									
SL-1	1/16	1.59	1.27	3/8	9.52	5/16	7.93	8.63	10.92	14.00	17.88
SL-2	1/8	3.17	2.28	3/8	9.52	7/16	11.11	12.70	15.24	15.74	22.35
SL-3	3/16	4.76	3.04	1/2	12.70	1/2	12.70	13.71	16.00	17.78	24.38
SL-4	1/4	6.35	4.82	1/2	12.70	9/16	14.28	15.24	17.78	19.55	26.92
SL-5	5/16	7.93	6.35	9/16	14.28	5/8	15.87	16.25	18.54	21.33	28.70
SL-6	3/8	9.52	7.11	5/8	15.87	11/16	17.46	16.76	19.30	23.11	30.48
SL-8	1/2	12.70	10.41	13/16	20.64	7/8	22.22	22.86	21.84	25.90	36.06
SL-10	5/8	15.87	12.70	15/16	23.81	1	25.40	24.38	21.84	28.70	38.80
SL-12	3/4	19.05	15.74	1-1/16	26.98	1-1/8	28.58	24.38	21.84	29.71	39.87
SL-14	7/8	22.22	18.28	1-1/4	31.75	1-1/4	31.75	25.90	21.84	34.54	44.70
SL-16	1	25.40	22.35	1-3/8	34.9	1-1/2	38.10	31.24	26.41	36.83	49.02
SL-20	1-1/4	31.75	27.68	1-11/16	42.86	1-7/8	47.63	41.14	38.86	44.50	66.54
SL-24	1-1/2	38.10	34.03	2	50.80	2-1/4	57.15	50.03	45.21	50.80	77.97
SL-32	2	50.80	45.97	2-3/4	69.85	3	76.20	67.56	62.73	69.80	107.18

### Connects metric tube

Part No.	Tube O.D. D	E Min.	Width across flat		A	B	l	L
			h	H				
SL-2M	2	1.7	9.5	12	12.9	15.3	15.7	22.3
SL-3M	3	2.4	9.5	12	12.9	15.3	15.7	22.3
SL-4M	4	2.4	12.7	12	13.7	16.4	18.8	25.4
SL-6M	6	4.8	12.7	14	15.3	17.7	19.6	27.0
SL-8M	8	6.4	14.3	16	16.2	18.6	21.3	28.8
SL-10M	10	7.9	17.5	19	17.2	19.5	23.9	31.5
SL-12M	12	9.5	20.6	22	22.8	22.0	25.9	36.0
SL-15M	15	11.9	25.4	25	24.4	22.0	28.7	38.8
SL-16M	16	12.7	25.4	25	24.4	22.0	28.7	38.8
SL-18M	18	15.1	27.0	30	24.4	22.0	29.7	39.8
SL-20M	20	15.9	31.8	32	26.0	22.0	34.5	42.6
SL-22M	22	18.3	31.8	32	26.0	22.0	34.5	42.6
SL-25M	25	21.8	34.9	38	31.3	26.5	36.8	49.1
SL-28M	28	21.8	41.0	46	36.6	36.6	43.2	64.0
SL-32M	32	28.6	46.0	50	42.0	41.6	49.3	72.3
SL-38M	38	33.7	55.0	60	49.4	47.9	56.4	84.0

## Reducing Union SUR

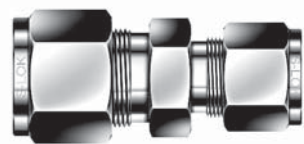
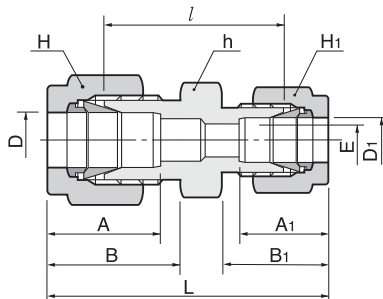

Connects fractional tube

Part No.	Tube O.D.				E Min.	Width across flat						A	A <sub>1</sub>	B	B <sub>1</sub>	l	L
	D		D <sub>1</sub>			h		H		H <sub>1</sub>							
	in	mm	in	mm		in	mm	in	mm	in	mm						
SUR-2-1	1/8	3.18	1/16	1.59	1.27	7/16	11.11	7/16	11.11	5/16	7.93	12.70	8.63	15.24	10.92	20.60	30.91
SUR-3-1	3/16	4.76	1/16	1.59	1.27	7/16	11.11	1/2	12.70	5/16	7.93	13.71	8.63	16.00	10.92	21.84	32.25
SUR-3-2	3/16	4.76	1/8	3.17	2.28	7/16	11.11	1/2	12.70	7/16	11.11	13.71	12.70	16.00	15.24	23.36	36.57
SUR-4-1	1/4	6.35	1/16	1.59	1.27	1/2	12.70	9/16	14.28	5/16	7.93	15.24	8.63	17.78	10.92	23.11	34.29
SUR-4-2	1/4	6.35	1/8	3.17	2.28	1/2	12.70	9/16	14.28	7/16	11.11	15.24	12.70	17.78	15.24	24.63	38.60
SUR-4-3	1/4	6.35	3/16	4.76	3.04	1/2	12.70	9/16	14.28	1/2	12.70	15.24	13.71	17.78	16.00	25.40	39.37
SUR-5-2	5/16	7.93	1/8	3.17	2.28	9/16	14.28	5/8	15.87	7/16	11.11	16.25	12.70	18.54	15.24	25.90	39.87
SUR-5-4	5/16	7.93	1/4	6.35	4.82	9/16	14.28	5/8	15.87	9/16	14.28	16.25	15.24	18.54	17.78	27.43	42.16
SUR-6-1	3/8	9.52	1/16	1.59	1.27	5/8	15.87	11/16	17.46	5/16	7.93	16.76	8.63	19.30	10.92	25.40	36.57
SUR-6-2	3/8	9.52	1/8	3.17	2.28	5/8	15.87	11/16	17.46	7/16	11.11	16.76	12.70	19.30	15.24	26.92	40.89
SUR-6-4	3/8	9.52	1/4	6.35	4.82	5/8	15.87	11/16	17.46	9/16	14.28	16.76	15.24	19.30	17.78	28.44	43.18
SUR-6-5	3/8	9.52	5/16	7.93	6.35	5/8	15.87	11/16	17.46	5/8	15.87	16.76	16.25	19.30	18.54	29.46	44.19
SUR-8-2	1/2	12.70	1/8	3.17	2.28	13/16	20.64	7/8	22.22	7/16	11.11	22.86	12.70	21.84	15.24	28.44	45.21
SUR-8-4	1/2	12.70	1/4	6.35	4.82	13/16	20.64	7/8	22.22	9/16	14.28	22.86	15.24	21.84	17.78	29.46	46.99
SUR-8-6	1/2	12.70	3/8	9.52	7.11	13/16	20.64	7/8	22.22	11/16	17.46	22.86	16.76	21.84	19.30	30.98	48.51
SUR-10-6	5/8	15.87	3/8	9.52	7.11	15/16	23.81	1	25.40	11/16	17.46	24.38	16.76	21.84	19.30	31.75	49.27
SUR-10-8	5/8	15.87	1/2	12.70	10.41	15/16	23.81	1	25.40	7/8	22.22	24.38	22.86	21.84	21.84	31.75	52.07
SUR-12-4	3/4	19.05	1/4	6.35	4.82	1-1/16	26.98	1-1/8	28.57	9/16	14.48	24.38	15.24	21.84	17.78	31.75	49.27
SUR-12-6	3/4	19.05	3/8	9.52	7.11	1-1/16	26.98	1-1/8	28.57	11/16	17.46	24.38	16.76	21.84	19.30	33.27	50.80
SUR-12-8	3/4	19.05	1/2	12.70	10.41	1-1/16	26.98	1-1/8	28.57	7/8	22.22	24.38	22.86	21.84	21.84	33.27	53.59
SUR-12-10	3/4	19.05	5/8	15.87	12.70	1-1/16	26.98	1-1/8	28.57	1	25.40	24.38	24.38	21.84	21.84	33.27	53.59
SUR-16-8	1	25.40	1/2	12.70	10.41	1-3/8	34.92	1-1/2	38.10	7/8	22.22	31.24	22.86	26.41	21.84	40.89	63.24
SUR-16-12	1	25.40	3/4	19.05	15.74	1-3/8	34.92	1-1/2	38.10	1-1/8	28.58	31.24	24.38	26.41	21.84	40.38	62.73



Reducing Union  
**SUR**

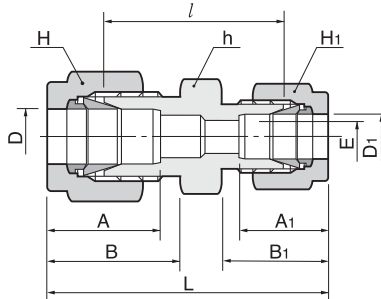

Connects metric tube

Part No	Tube O.D.		E Min.	Width across flat			A	A <sub>1</sub>	B	B <sub>1</sub>	l	L
	D	D <sub>1</sub>		h	H	H <sub>1</sub>						
SUR - 3M-2M	3	2	1.7	12	12	12	12.9	12.9	15.3	15.3	22.1	35.3
SUR - 6M-2M	6	2	1.7	14	14	12	15.3	12.9	17.7	15.3	24.6	38.6
SUR - 6M-3M	6	3	2.4	14	14	12	15.3	12.9	17.7	15.3	24.6	38.6
SUR - 6M-4M	6	4	2.4	14	14	12	15.3	13.7	17.7	16.1	25.4	39.4
SUR - 8M-6M	8	6	4.8	15	16	14	16.2	15.3	18.6	17.7	27.4	42.3
SUR - 10M-6M	10	6	4.8	18	19	14	17.2	15.3	19.5	17.7	29.5	44.5
SUR - 10M-8M	10	8	6.4	18	19	16	17.2	16.2	19.5	18.6	30.0	45.1
SUR - 12M-6M	12	6	4.8	22	22	14	22.8	15.3	22.0	17.7	29.5	47.0
SUR - 12M-8M	12	8	6.4	22	22	16	22.8	16.2	22.0	18.6	30.2	47.8
SUR - 12M-10M	12	10	7.9	22	22	19	22.8	17.2	22.0	19.5	31.0	48.7
SUR - 16M-10M	16	10	7.9	24	25	19	24.4	17.2	22.0	19.5	31.8	49.5
SUR - 16M-12M	16	12	9.5	24	25	22	24.4	22.8	22.0	22.0	31.8	52.0
SUR - 18M-12M	18	12	9.5	27	30	22	24.4	22.8	22.0	22.0	33.3	53.5
SUR - 25M-18M	25	18	15.1	35	38	30	31.3	24.4	26.5	22.0	38.6	61.0
SUR - 25M-20M	25	20	15.9	35	38	32	31.3	26.0	26.5	22.0	39.9	62.3

Connects metric tube to fractional tube

Part No.	Tube O.D.		E Min.	Width across flat			A	A <sub>1</sub>	B	B <sub>1</sub>	l	L	
	D	D <sub>1</sub>		h	H	H <sub>1</sub>							
		in	mm										
SUR - 3M-2	3	1/8	3.17	2.4	12	12	11.1	12.9	12.8	15.3	15.2	22.1	35.2
SUR - 4M-2	4	1/8	3.17	2.4	12	12	11.1	13.7	12.8	16.1	15.2	23.4	36.5
SUR - 4M-4	4	1/4	6.35	2.4	14	12	14.3	13.7	15.3	16.1	17.7	25.4	39.4
SUR - 6M-2	6	1/8	3.17	2.4	14	14	11.1	15.3	12.8	17.7	15.2	24.6	38.5
SUR - 6M-4	6	1/4	6.35	4.8	14	14	14.3	15.3	15.8	17.7	17.7	26.2	41.0
SUR - 6M-5	6	5/16	7.93	4.8	14	14	15.9	15.3	16.2	17.7	18.6	27.4	42.3
SUR - 8M-4	8	1/4	6.35	4.8	15	16	14.3	16.2	15.3	18.6	17.7	27.4	42.3
SUR - 10M-2	10	1/8	3.17	2.4	18	19	11.1	17.2	12.8	19.5	15.2	27.7	41.8
SUR - 10M-4	10	1/4	6.35	4.8	18	19	14.3	17.2	15.3	19.5	17.7	29.5	44.5
SUR - 10M-5	10	5/16	7.93	6.4	18	19	15.9	17.2	16.2	19.5	18.6	30.3	45.1
SUR - 10M-6	10	3/8	9.52	7.1	18	19	17.5	17.2	16.9	19.5	18.6	31.0	45.9
SUR - 12M-5	12	5/16	7.93	6.4	22	22	15.9	22.8	16.2	22.0	18.6	30.2	47.8
SUR - 12M-6	12	3/8	9.52	7.1	22	22	17.5	22.8	16.9	22.0	19.2	31.0	48.4
SUR - 12M-8	12	1/2	12.70	9.5	22	22	22.2	22.8	22.8	22.0	22.0	31.0	51.2
SUR - 15M-8	15	1/2	12.70	10.3	24	25	22.2	24.4	22.8	22.0	22.0	31.8	52.0
SUR - 16M-10	16	5/8	15.87	12.7	24	25	25.4	24.4	24.4	22.0	22.0	31.8	52.0
SUR - 18M-12	18	3/4	19.05	15.1	27	30	28.6	24.4	24.4	22.0	22.0	33.3	53.5
SUR - 20M-12	20	3/4	19.05	15.9	30	32	28.6	26.0	24.4	22.0	22.0	34.8	54.9
SUR - 20M-16	20	1	25.40	15.9	34.9	32	38.1	26.0	31.2	22.0	26.4	38.0	60.3
SUR - 22M-16	22	1	25.40	18.3	34.9	32	38.1	26.0	31.2	22.0	26.4	38.2	60.3

## Union Tee ST

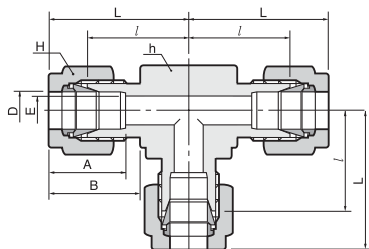

### Connects fractional tube

Part No.	Tube O.D.		E Min.	Width across flat				A	B	l	L
	D in	mm		h in	mm	H in	mm				
ST-1	1/16	1.59	1.27	3/8	9.52	5/16	7.93	8.63	10.92	14.00	17.88
ST-2	1/8	3.17	2.28	3/8	9.52	7/16	11.11	12.70	15.24	15.74	22.35
ST-3	3/16	4.76	3.04	1/2	12.70	1/2	12.70	13.71	16.00	17.78	24.38
ST-4	1/4	6.35	4.82	1/2	12.70	9/16	14.28	15.24	17.78	19.55	26.92
ST-5	5/16	7.93	6.35	9/16	14.28	5/8	15.87	16.25	18.54	21.33	28.70
ST-6	3/8	9.52	7.11	5/8	15.87	11/16	17.46	16.76	19.30	23.11	30.48
ST-8	1/2	12.70	10.41	13/16	20.64	7/8	22.22	22.86	21.84	25.90	36.06
ST-10	5/8	15.87	12.70	15/16	23.81	1	25.40	24.38	21.84	28.70	38.80
ST-12	3/4	19.05	15.74	1-1/16	26.98	1-1/8	28.58	24.38	21.84	29.71	39.87
ST-14	7/8	22.22	18.28	1-1/4	31.75	1-1/4	31.75	25.90	21.84	34.54	44.70
ST-16	1	25.40	22.35	1-3/8	34.9	1-1/2	38.10	31.24	26.41	36.83	49.02
ST-20	1-1/4	31.75	27.68	1-11/16	42.86	1-7/8	47.63	41.14	38.86	44.50	66.54
ST-24	1-1/2	38.10	34.03	2	50.80	2-1/4	57.15	50.03	45.21	50.80	77.97
ST-32	2	50.80	45.97	2-3/4	69.85	3	76.20	67.56	62.73	69.80	107.18

### Connects metric tube

Part No.	Tube O.D.	E Min.	Width across flat		A	B	l	L
	D		h	H				
ST-2M	2	1.7	9.5	12	12.9	15.3	15.7	22.3
ST-3M	3	2.4	9.5	12	12.9	15.3	15.7	22.3
ST-4M	4	2.4	12.7	12	13.7	16.1	18.8	25.4
ST-6M	6	4.8	12.7	14	15.3	17.7	19.6	27.0
ST-8M	8	6.4	14.3	16	16.2	18.6	21.3	28.8
ST-10M	10	7.9	17.5	19	17.2	19.5	23.9	31.5
ST-12M	12	9.5	20.6	22	22.8	22.0	25.9	36.0
ST-15M	15	11.9	25.4	25	24.4	22.0	28.7	38.8
ST-16M	16	12.7	25.4	25	24.4	22.0	28.7	38.8
ST-18M	18	15.1	27.0	30	24.4	22.0	29.7	39.8
ST-20M	20	15.9	31.8	32	26.0	22.0	32.5	42.6
ST-22M	22	18.3	31.8	32	26.0	22.0	32.5	42.6
ST-25M	25	21.8	34.9	38	31.3	26.5	36.8	49.1
ST-28M	28	21.8	41.0	46	36.6	36.6	43.2	64.0
ST-32M	32	28.6	46.0	50	42.0	41.6	49.3	72.3
ST-38M	38	33.7	55.0	60	49.4	47.9	56.4	84.0

## Union Cross SX

Note :  
Cross may be made from  
plate stock

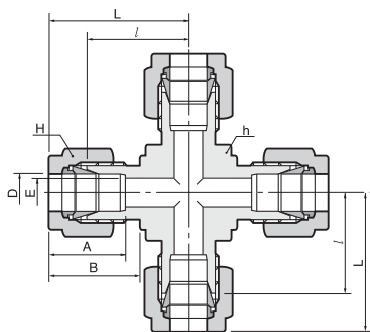

### Connects fractional tube

Part No.	Tube O.D.		E Min.	Width across flat				A	B	l	L
	in	mm		h		H					
SX-1	1/16	1.59	1.27	3/8	9.52	5/16	7.93	8.63	10.92	14.00	17.88
SX-2	1/8	3.17	2.28	3/8	9.52	7/16	11.11	12.70	15.24	15.74	22.35
SX-3	3/16	4.76	3.04	1/2	12.70	1/2	12.70	13.71	16.00	17.78	24.38
SX-4	1/4	6.35	4.82	1/2	12.70	9/16	14.28	15.24	17.78	19.55	26.92
SX-5	5/16	7.93	6.35	1/2	12.70	5/8	15.87	16.25	18.54	21.33	28.70
SX-6	3/8	9.52	7.11	11/16	17.46	11/16	17.46	16.76	19.30	23.11	30.48
SX-8	1/2	12.70	10.41	13/16	20.64	7/8	22.22	22.86	21.84	25.90	36.06
SX-10	5/8	15.87	12.70	13/16	20.64	1	25.40	24.38	21.84	28.70	38.80
SX-12	3/4	19.05	15.74	1	25.40	1-1/8	28.58	24.38	21.84	29.71	39.87
SX-14	7/8	22.22	18.28	1-1/4	31.75	1-1/4	31.75	25.90	21.84	34.54	44.70
SX-16	1	25.40	22.35	1-27/64	36.12	1-1/2	38.10	31.24	26.41	36.83	49.02
SX-20	1-1/4	31.75	27.68	1-11/16	42.86	1-7/8	47.63	41.14	38.86	44.50	66.54
SX-24	1-1/2	38.10	34.03	2	50.80	2-1/4	57.15	50.03	45.21	50.80	77.97
SX-32	2	50.80	45.97	2-3/4	69.85	3	76.20	67.56	62.73	69.80	107.18

### Connects metric tube

Part No.	Tube O.D.	E Min.	Width across flat		A	B	l	L
	D		h	H				
SX-3M	3	2.4	9.5	12	12.9	15.3	15.7	22.3
SX-4M	4	2.4	12.7	12	13.7	16.1	18.8	25.4
SX-6M	6	4.8	12.7	14	15.3	17.7	19.6	27.0
SX-8M	8	6.4	14.3	16	16.2	18.6	21.3	28.8
SX-10M	10	7.9	17.5	19	17.2	19.5	23.9	31.5
SX-12M	12	9.5	20.6	22	22.8	22.0	25.9	36.0
SX-15M	15	11.9	25.4	25	24.4	22.0	28.7	38.8
SX-16M	16	12.7	25.4	25	24.4	22.0	28.7	38.8
SX-18M	18	15.1	27.0	30	24.4	22.0	29.7	39.8
SX-20M	20	15.9	31.8	32	26.0	22.0	32.5	42.6
SX-22M	22	18.3	31.8	32	26.0	22.0	32.5	42.6
SX-25M	25	21.8	36.0	38	31.3	26.5	36.8	49.1
SX-28M	28	21.8	41.0	46	36.6	36.6	43.2	64.0
SX-32M	32	28.6	46.0	50	42.0	41.6	49.3	72.3
SX-38M	38	33.7	55.0	60	49.4	47.9	56.4	84.0

# S-LOK Tube Fittings

## Bulkhead Union SUB

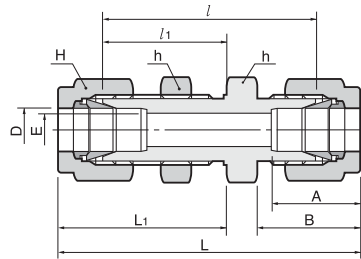

### Connects fractional tube

Part No.	Tube O.D.		E Min.	Width across flat				A	B	l	l <sub>1</sub>	L	L <sub>1</sub>	Panel Hole Drill size	Panel Max Thickness
	in	mm		h	mm	in	H								
SUB-1	1/16	1.59	1.27	5/16	7.93	5/16	7.93	8.63	10.92	23.87	13.46	31.50	17.27	5.16	3.05
SUB-2	1/8	3.17	2.28	1/2	12.70	7/16	11.11	12.70	15.24	38.10	24.63	51.30	31.24	8.33	12.70
SUB-3	3/16	4.76	3.04	9/16	14.28	1/2	12.70	13.71	16.00	40.38	25.40	53.59	32.00	9.92	12.70
SUB-4	1/4	6.35	4.82	5/8	15.87	9/16	14.28	15.24	17.78	42.92	26.16	57.65	33.52	11.50	10.16
SUB-5	5/16	7.93	6.35	11/16	17.46	5/8	15.87	16.25	18.54	45.97	28.44	60.70	35.81	13.09	11.17
SUB-6	3/8	9.52	7.11	3/4	19.05	11/16	17.46	16.76	19.30	47.49	29.46	62.23	36.83	14.68	11.17
SUB-8	1/2	12.70	10.41	15/16	23.81	7/8	22.22	22.86	21.84	50.80	31.75	71.12	41.91	19.44	12.70
SUB-10	5/8	15.87	12.70	1-1/16	26.98	1	25.40	24.38	21.84	52.32	32.51	72.64	42.67	22.62	12.70
SUB-12	3/4	19.05	15.74	1-3/16	30.16	1-1/8	28.58	24.38	21.84	58.67	37.33	78.99	47.49	25.79	16.76
SUB-14	7/8	22.22	18.28	1-3/8	34.92	1-1/4	31.75	25.90	21.84	64.26	42.92	84.58	53.08	28.97	19.05
SUB-16	1	25.40	22.35	1-5/8	41.27	1-1/2	38.10	31.24	26.41	71.37	45.21	95.75	57.40	33.73	19.05
SUB-20	1-1/4	31.75	27.68	1-7/8	47.63	1-7/8	47.63	41.14	38.86	78.99	47.75	123.19	69.85	41.67	19.05
SUB-24	1-1/2	38.10	34.03	2-1/4	57.15	2-1/4	57.15	50.03	45.21	84.83	49.27	139.19	76.45	49.61	19.05
SUB-32	2	50.80	45.97	2-3/4	69.85	3	76.20	67.56	62.73	105.66	56.38	180.34	93.72	57.94	19.05

### Connects metric tube

Part No.	Tube O.D.		E Min.	Width across flat		A	B	l	l <sub>1</sub>	L	L <sub>1</sub>	Panel Hole Drill size	Panel Max Thickness
	D			h	H								
SUB-3M	3		2.4	14	12	12.9	15.3	38.1	24.6	51.3	31.2	8.3	12.7
SUB-4M	4		2.4	14	12	13.7	16.1	40.4	25.4	53.6	32.0	9.9	12.7
SUB-6M	6		4.8	16	14	15.3	17.7	42.9	26.2	57.7	33.6	11.5	10.2
SUB-8M	8		6.4	18	16	16.2	18.6	46.0	28.6	61.0	36.1	13.1	11.2
SUB-10M	10		7.9	22	19	17.2	19.5	48.5	29.4	63.7	37.0	16.2	11.2
SUB-12M	12		9.5	24	22	22.8	22.0	50.8	31.8	71.0	41.9	19.5	12.7
SUB-15M	15		11.9	27	25	24.4	22.0	52.3	32.5	72.5	42.6	22.8	12.7
SUB-16M	16		12.7	27	25	24.4	22.0	52.3	32.5	72.5	42.6	22.8	12.7
SUB-18M	18		15.1	30	30	24.4	22.0	58.7	37.3	78.9	47.4	26.0	16.8
SUB-20M	20		15.9	35	32	26.0	22.0	64.3	42.9	84.5	53.0	29.0	17.0
SUB-22M	22		18.3	35	32	26.0	22.0	64.3	42.9	84.5	53.0	29.0	19.1
SUB-25M	25		21.8	41.3	38	31.3	26.5	71.4	45.2	95.9	57.5	33.7	19.1
SUB-32M	32		28.6	50	50	42.0	41.6	82.3	49.5	128.3	72.5	42.5	19.0
SUB-38M	38		33.7	60	60	49.4	47.9	89.4	51.5	144.6	79.1	50.5	19.0

Male Connector  
**SMC-N**

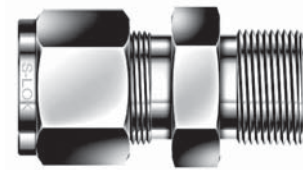
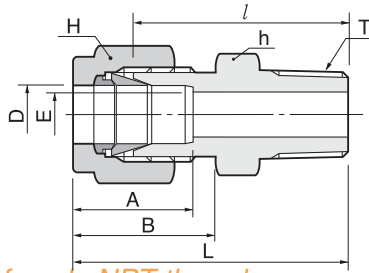

Connects fractional tube to female NPT thread

Part No.	Tube O.D. D		T (NPT)	E Min.	Width across flat				A	B	l	L
	in	mm			h	mm	in	H				
SMC-1-1N	1/16	1.59	1/16	1.27	5/16	7.93	5/16	7.93	8.63	10.92	20.00	23.83
SMC-1-2N	1/16	1.59	1/8	1.27	7/16	11.11	5/16	7.93	8.63	10.92	22.35	26.23
SMC-1-4N	1/16	1.59	1/4	1.27	9/16	14.28	5/16	7.93	8.63	10.92	27.17	30.98
SMC-2-1N	1/8	3.17	1/16	2.28	7/16	11.11	7/16	11.11	12.70	15.24	23.11	29.71
SMC-2-2N	1/8	3.17	1/8	2.28	7/16	11.11	7/16	11.11	12.70	15.24	23.87	30.48
SMC-2-4N	1/8	3.17	1/4	2.28	9/16	14.28	7/16	11.11	12.70	15.24	28.95	35.56
SMC-2-6N	1/8	3.17	3/8	2.28	11/16	17.46	7/16	11.11	12.70	15.24	29.21	35.81
SMC-2-8N	1/8	3.17	1/2	2.28	7/8	22.22	7/16	11.11	12.70	15.24	35.56	42.16
SMC-3-2N	3/16	4.76	1/8	3.04	7/16	11.11	1/2	12.70	13.71	16.00	24.63	31.24
SMC-3-4N	3/16	4.76	1/4	3.04	9/16	14.28	1/2	12.70	13.71	16.00	29.71	36.32
SMC-4-1N	1/4	6.35	1/16	4.82	1/2	12.70	9/16	14.28	15.24	17.78	25.40	32.76
SMC-4-2N	1/4	6.35	1/8	4.82	1/2	12.70	9/16	14.28	15.24	17.78	25.40	32.76
SMC-4-4N	1/4	6.35	1/4	4.82	9/16	14.28	9/16	14.28	15.24	17.78	30.48	37.84
SMC-4-6N	1/4	6.35	3/8	4.82	11/16	17.46	9/16	14.28	15.24	17.78	30.98	38.35
SMC-4-8N	1/4	6.35	1/2	4.82	7/8	22.22	9/16	14.28	15.24	17.78	37.33	44.70
SMC-4-12N	1/4	6.35	3/4	4.82	1-1/16	26.98	9/16	14.28	15.24	17.78	38.86	46.22
SMC-5-2N	5/16	7.93	1/8	4.82	9/16	14.28	5/8	15.87	16.25	18.54	26.67	34.03
SMC-5-4N	5/16	7.93	1/4	6.35	9/16	14.28	5/8	15.87	16.25	18.54	31.24	38.60
SMC-5-6N	5/16	7.93	3/8	6.35	11/16	17.46	5/8	15.87	16.25	18.54	31.75	39.11
SMC-5-8N	5/16	7.93	1/2	6.35	7/8	22.22	5/8	15.87	16.25	18.54	38.11	45.60
SMC-6-2N	3/8	9.52	1/8	4.82	5/8	15.87	11/16	17.46	16.76	19.30	27.94	35.30
SMC-6-4N	3/8	9.52	1/4	7.11	5/8	15.87	11/16	17.46	16.76	19.30	32.51	39.87
SMC-6-6N	3/8	9.52	3/8	7.11	11/16	17.46	11/16	17.46	16.76	19.30	32.51	39.87
SMC-6-8N	3/8	9.52	1/2	7.11	7/8	22.22	11/16	17.46	16.76	19.30	38.86	46.22
SMC-6-12N	3/8	9.52	3/4	7.11	1-1/16	26.98	11/16	17.46	16.76	19.30	40.38	47.75
SMC-8-2N	1/2	12.70	1/8	4.82	13/16	20.64	7/8	22.22	22.86	21.84	28.70	38.86
SMC-8-4N	1/2	12.70	1/4	7.11	13/16	20.64	7/8	22.22	22.86	21.84	33.27	43.43
SMC-8-6N	1/2	12.70	3/8	9.65	13/16	20.64	7/8	22.22	22.86	21.84	33.27	43.43
SMC-8-8N	1/2	12.70	1/2	10.41	7/8	22.22	7/8	22.22	22.86	21.84	38.86	49.02
SMC-8-12N	1/2	12.70	3/4	10.41	1-1/16	26.98	7/8	22.22	22.86	21.84	40.38	50.54
SMC-8-16N	1/2	12.70	1	10.41	1-3/8	34.92	7/8	22.22	22.86	21.84	46.99	57.15
SMC-10-6N	5/8	15.87	3/8	9.65	15/16	23.81	1	25.40	24.38	21.84	34.03	44.19
SMC-10-8N	5/8	15.87	1/2	11.93	15/16	23.81	1	25.40	24.38	21.84	38.86	49.02
SMC-10-12N	5/8	15.87	3/4	12.70	1-1/16	26.98	1	25.40	24.38	21.84	40.38	50.54
SMC-12-8N	3/4	19.05	1/2	11.93	1-1/16	26.98	1-1/8	28.58	24.38	21.84	40.38	50.54
SMC-12-12N	3/4	19.05	3/4	15.74	1-1/16	26.98	1-1/8	28.58	24.38	21.84	40.38	50.54
SMC-12-16N	3/4	19.05	1	15.74	1-3/8	34.92	1-1/8	28.58	24.38	21.84	46.99	57.15
SMC-14-12N	7/8	22.22	3/4	15.74	1-3/16	30.16	1-1/4	31.75	25.90	21.84	40.38	50.54
SMC-14-16N	7/8	22.22	1	18.28	1-3/8	34.92	1-1/4	31.75	25.90	21.84	46.99	57.15
SMC-16-8N	1	25.40	1/2	11.93	1-3/8	34.92	1-1/2	38.10	31.24	26.41	45.21	57.40
SMC-16-12N	1	25.40	3/4	15.74	1-3/8	34.92	1-1/2	38.10	31.24	26.41	45.21	57.40
SMC-16-16N	1	25.40	1	22.35	1-3/8	34.92	1-1/2	38.10	31.24	26.41	50.03	62.23
SMC-20-16N	1-1/4	31.75	1	22.35	1-3/4	44.45	1-7/8	47.63	41.14	38.86	55.11	77.21
SMC-20-20N	1-1/4	31.75	1-1/4	27.68	1-3/4	44.45	1-7/8	47.63	41.14	38.86	55.11	77.21
SMC-20-24N	1-1/4	31.75	1-1/2	27.68	1-3/4	44.45	1-7/8	47.63	41.14	38.86	60.54	82.64
SMC-24-20N	1-1/2	38.10	1-1/4	27.68	2-1/8	53.98	2-1/4	57.15	50.03	45.21	59.42	86.60
SMC-24-24N	1-1/2	38.10	1-1/2	34.03	2-1/8	53.98	2-1/4	57.15	50.03	45.21	61.72	88.90
SMC-24-32N	1-1/2	38.10	2	34.03	2-3/4	69.85	2-1/4	57.15	50.03	45.21	62.42	99.75
SMC-32-8N	2	50.80	1/2	11.93	2-3/4	69.85	3	76.20	67.56	62.73	68.40	105.73
SMC-32-20N	2	50.80	1-1/4	45.97	2-3/4	69.85	3	76.20	67.56	62.73	71.40	108.73
SMC-32-24N	2	50.80	1-1/2	45.97	2-3/4	69.85	3	76.20	67.56	62.73	75.50	112.83
SMC-32-32N	2	50.80	2	45.97	2-3/4	69.85	3	76.20	67.56	62.73	76.20	113.53

## S-LOK Tube Fittings

### Male Connector SMC-R

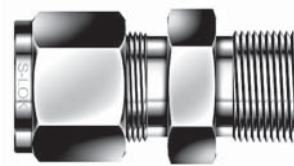
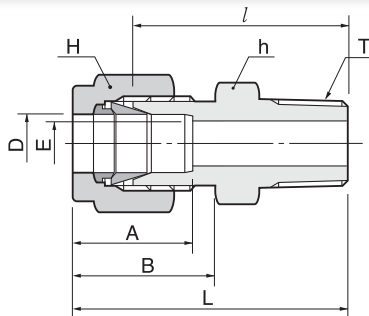

Connects metric tube to female ISO tapered thread

Part No.	Tube O.D.		E Min.	Width across flat		A	B	l	L
	D	T R(PT)		h	H				
SMC-2M-2R	2	1/8	1.7	12	12	12.9	15.3	23.9	30.5
SMC-3M-2R	3	1/8	2.4	12	12	12.9	15.3	23.1	29.7
SMC-3M-4R	3	1/4	2.4	14	12	12.9	15.3	29.0	35.6
SMC-4M-2R	4	1/8	2.4	12	12	13.7	16.1	24.6	31.2
SMC-4M-4R	4	1/4	2.4	14	12	13.7	16.1	29.7	36.3
SMC-6M-2R	6	1/8	4.8	14	14	15.3	17.7	25.4	32.8
SMC-6M-4R	6	1/4	4.8	14	14	15.3	17.7	30.2	37.6
SMC-6M-6R	6	3/8	4.8	18	14	15.3	17.7	31.0	38.4
SMC-6M-8R	6	1/2	4.8	22	14	15.3	17.7	36.6	44.0
SMC-8M-2R	8	1/8	4.8	15	16	16.2	18.6	26.7	34.2
SMC-8M-4R	8	1/4	6.4	15	16	16.2	18.6	31.2	38.7
SMC-8M-6R	8	3/8	6.4	18	16	16.2	18.6	31.8	39.2
SMC-8M-8R	8	1/2	6.4	22	16	16.2	18.6	37.3	44.8
SMC-10M-2R	10	1/8	4.8	18	19	17.2	19.5	28.7	36.3
SMC-10M-4R	10	1/4	7.1	18	19	17.2	19.5	33.3	40.9
SMC-10M-6R	10	3/8	7.9	18	19	17.2	19.5	33.3	40.9
SMC-10M-8R	10	1/2	7.9	22	19	17.2	19.5	38.1	45.7
SMC-12M-4R	12	1/4	7.1	22	22	22.8	22.0	33.3	43.4
SMC-12M-6R	12	3/8	9.5	22	22	22.8	22.0	33.3	43.4
SMC-12M-8R	12	1/2	9.5	22	22	22.8	22.0	38.1	48.2
SMC-12M-12R	12	3/4	9.5	27	22	22.8	22.0	38.9	49.0
SMC-15M-8R	15	1/2	11.9	24	25	24.4	22.0	38.9	49.0
SMC-16M-4R	16	1/4	7.1	24	25	24.4	22.0	34.0	44.1
SMC-16M-6R	16	3/8	9.5	24	25	24.4	22.0	34.0	44.1
SMC-16M-8R	16	1/2	11.9	24	25	24.4	22.0	38.9	49.0
SMC-16M-12R	16	3/4	12.7	27	25	24.4	22.0	38.9	49.0
SMC-18M-8R	18	1/2	11.9	27	30	24.4	22.0	40.4	50.5
SMC-18M-12R	18	3/4	15.1	27	30	24.4	22.0	40.4	50.5
SMC-20M-8R	20	1/2	11.9	30	32	26.0	22.0	42.2	52.3
SMC-20M-12R	20	3/4	15.9	30	32	26.0	22.0	42.2	52.3
SMC-22M-12R	22	3/4	15.9	30	32	26.0	22.0	42.2	52.3
SMC-22M-16R	22	1	18.3	35	32	26.0	22.0	47.8	57.9
SMC-25M-12R	25	3/4	15.9	35	38	31.3	26.5	45.2	57.5
SMC-25M-16R	25	1	21.8	35	38	31.3	26.5	50.0	62.3
SMC-28M-16R	28	1	21.8	41	46	36.6	36.6	51.6	72.4
SMC-28M-20R	28	1-1/4	21.8	46	46	36.6	36.6	52.3	73.1
SMC-32M-20R	32	1-1/4	28.6	46	50	42.0	41.6	56.6	79.6
SMC-38M-24R	38	1-1/2	33.7	55	60	49.4	47.9	64.0	91.6

### Thermocouple Connector SMCT

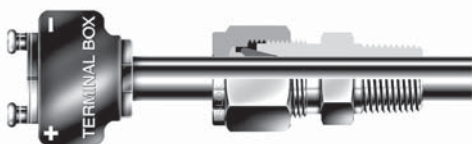

S-LOK thermocouple connector has no shoulder nor sizing angle inside the fitting, the features enable thermocoupler to go through fitting's thread end. Suffix "T" to Male Connector identifier.

Example : SMCT 8-8N-S for ordering Thermocouple connector  
O.D 1/2" x 1/2" NPT S316.

#### Assembly Instructions

1. Position the length of the Thermocouple passed through fitting's thread end and hold it to prevent shifting during assembly.
2. Turn the nut 1-1/4 after finger tight with a wrench by holding the body with a back up wrench for size 1/4" (6mm) or above.

Male Connector  
for Bonded Seal  
**SMC-G**

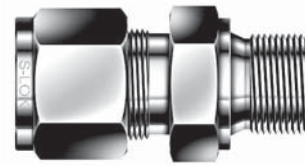
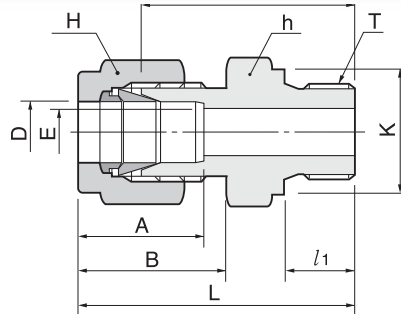

Connects fractional tube to female ISO parallel thread

Part No.	Tube O.D.		T (PF)	E Min.	Width across flat				A	B	l	l <sub>1</sub>	L	K
	D				h	H								
	in	mm					in	mm						
SMC-2-2G	1/8	3.17	1/8	2.28	9/16	14.28	7/16	11.11	12.70	15.24	23.37	7.11	29.97	13.72
SMC-2-4G	1/8	3.17	1/4	2.28	3/4	19.05	7/16	11.11	12.70	15.24	28.70	11.18	35.31	18.03
SMC-2-6G	1/8	3.17	3/8	2.28	7/8	22.22	7/16	11.11	12.70	15.24	29.72	11.18	36.21	21.84
SMC-4-2G	1/4	6.35	1/8	2.28	9/16	14.28	9/16	14.28	15.24	17.78	24.89	7.11	32.26	13.72
SMC-4-4G	1/4	6.35	1/4	4.82	3/4	19.05	9/16	14.28	15.24	17.78	30.23	11.18	37.59	18.03
SMC-4-6G	1/4	6.35	3/8	4.82	7/8	22.22	9/16	14.28	15.24	17.78	31.50	11.18	38.86	21.84
SMC-4-8G	1/4	6.35	1/2	4.82	1-1/16	26.98	9/16	14.28	15.24	17.78	37.34	14.22	44.70	25.91
SMC-6-4G	3/8	9.53	1/4	4.82	3/4	19.05	11/16	17.46	16.76	19.30	31.75	11.18	39.12	18.03
SMC-6-6G	3/8	9.53	3/8	7.11	7/8	22.22	11/16	17.46	16.76	19.30	33.02	11.18	40.39	21.84
SMC-6-8G	3/8	9.53	1/2	7.11	1-1/16	26.98	11/16	17.46	16.76	19.30	38.86	14.22	46.23	25.91
SMC-8-4G	1/2	12.70	1/4	7.11	13/16	20.64	7/8	22.22	22.86	21.84	32.51	11.18	42.67	18.03
SMC-8-6G	1/2	12.70	3/8	9.65	7/8	22.22	7/8	22.22	22.86	21.84	33.02	11.18	43.18	21.84
SMC-8-8G	1/2	12.70	1/2	10.41	1-1/16	26.98	7/8	22.22	22.86	21.84	38.86	14.22	49.02	25.91
SMC-12-8G	3/4	19.05	1/2	11.93	1-1/16	26.98	1-1/8	28.58	24.38	21.84	38.86	14.22	49.02	25.91
SMC-12-12G	3/4	19.05	3/4	15.74	1-5/16	33.33	1-1/8	28.58	24.38	21.84	42.67	15.75	52.83	32.00
SMC-16-8G	1	25.40	1/2	11.93	1-3/8	34.92	1-1/2	38.10	31.24	26.41	43.69	14.22	55.88	25.91
SMC-16-16G	1	25.40	1	22.35	1-5/8	41.27	1-1/2	38.10	31.24	26.41	47.75	18.29	59.94	39.12
SMC-20-20G	1-1/4	31.75	1-1/4	27.68	2	50.80	1-7/8	47.63	41.14	38.86	51.16	20.00	73.26	49.00
SMC-24-24G	1-1/2	38.10	1-1/2	34.03	2-1/4	57.15	2-1/4	57.15	50.03	45.21	57.57	22.00	84.75	55.00

Connects metric tube to female ISO parallel thread

Part No.	Tube O.D.		T G(PF)	E Min.	Width across flat		A	B	l	l <sub>1</sub>	L	K
	D				h	H						
	in	mm										
SMC-2M-2G	2		1/8	1.7	14	12	12.9	15.3	23.4	7.1	30.0	13.8
SMC-3M-2G	3		1/8	2.4	14	12	12.9	15.3	23.4	7.1	30.0	13.8
SMC-3M-4G	3		1/4	2.4	19	12	12.9	15.3	28.7	11.2	35.3	18.0
SMC-4M-2G	4		1/8	2.4	14	12	13.7	16.1	24.1	7.1	30.7	13.8
SMC-4M-4G	4		1/4	2.4	19	12	13.7	16.1	29.4	11.2	36.0	18.0
SMC-6M-2G	6		1/8	4.0	14	14	15.3	17.7	24.9	7.1	32.3	13.8
SMC-6M-4G	6		1/4	4.8	19	14	15.3	17.7	30.2	11.2	37.6	18.0
SMC-6M-6G	6		3/8	4.8	22	14	15.3	17.7	31.5	11.2	38.9	21.8
SMC-6M-8G	6		1/2	4.8	27	14	15.3	17.7	37.3	14.2	44.7	26.0
SMC-8M-2G	8		1/8	4.0	15	16	16.2	18.6	25.7	7.1	33.2	13.8
SMC-8M-4G	8		1/4	6.4	19	16	16.2	18.6	31.0	11.2	38.5	18.0
SMC-8M-6G	8		3/8	6.4	22	16	16.2	18.6	32.3	11.2	39.8	21.8
SMC-8M-8G	8		1/2	6.4	27	16	16.2	18.6	38.1	14.2	45.6	26.0
SMC-10M-4G	10		1/4	6.4	19	19	17.2	19.5	31.8	11.2	39.4	18.0
SMC-10M-6G	10		3/8	7.9	22	19	17.2	19.5	33.0	11.2	40.6	21.8
SMC-10M-8G	10		1/2	7.9	27	19	17.2	19.5	38.9	14.2	46.5	26.0
SMC-12M-4G	12		1/4	5.9	22	22	22.8	22.0	32.5	11.2	42.6	18.0
SMC-12M-6G	12		3/8	7.9	22	22	22.8	22.0	33.0	11.2	43.1	21.8
SMC-12M-8G	12		1/2	9.5	27	22	22.8	22.0	38.9	14.2	49.0	26.0
SMC-12M-12G	12		3/4	9.5	35	22	22.8	22.0	42.7	15.7	52.8	32.0
SMC-16M-6G	16		3/8	7.9	24	25	24.4	22.0	33.8	11.2	43.9	21.8
SMC-16M-8G	16		1/2	11.9	27	25	24.4	22.0	38.9	14.2	49.0	26.0
SMC-18M-8G	18		1/2	11.9	27	30	24.4	22.0	38.9	14.2	49.0	26.0
SMC-18M-12G	18		3/4	15.1	35	30	24.4	22.0	42.7	15.7	52.8	32.0
SMC-20M-8G	20		1/2	11.9	30	32	26.0	22.0	40.4	14.2	50.5	26.0
SMC-20M-12G	20		3/4	15.9	35	32	26.0	22.0	42.7	15.7	52.8	32.0
SMC-22M-12G	22		3/4	15.9	35	32	26.0	22.0	42.7	15.7	52.8	32.0
SMC-22M-16G	22		1	18.3	41	32	26.0	22.0	45.2	18.3	55.3	39.0
SMC-25M-12G	25		3/4	15.9	35	38	31.3	26.5	45.2	15.7	57.5	32.0
SMC-25M-16G	25		1	19.8	41	38	31.3	26.5	47.8	18.3	60.1	39.0
SMC-28M-16G	28		1	19.8	41	46	36.6	36.6	49.3	18.3	70.1	39.0
SMC-28M-20G	28		1-1/4	21.8	50	46	36.6	36.6	53.1	19.8	73.9	49.0
SMC-32M-20G	32		1-1/4	25.0	50	50	42.0	41.6	55.9	19.8	78.9	49.0
SMC-38M-24G	38		1-1/2	31.8	55	60	49.4	47.9	63.2	22.1	90.8	54.7

## ISO Pipe Thread

The International Standards Organization created the ISO 228/1 and 7/1 threads to standardize the nomenclature of several international pipe threads.

### ISO 228/1

The ISO 228/1 is a parallel thread that is no sealing threads. The pressure tight seal is usually made metal to metal against the female port or with a gasket.

The ISO 228/1 is described in following codes.

1. BS 2779 (BSPP)
2. DIN-ISO 228/1
3. JIS B0202 (PF)
4. ISO 228/1

The ISO 228/1 threads sealing available in S-LOK are listed below.

A self-centering taper is constructed at the hex. This taper centers a bonded washer to seal to the surface surrounding the female thread.

#### SGB Bonded Seal Gasket (Buna inner ring bonded to carbon steel outer ring)

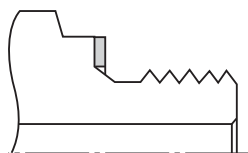

Sealing by compression against face of body  
Reference DIN 3852 Type A

Ordering Number	E		H		D	
	(mm)	(in.)	(mm)	(in.)	(mm)	(in.)
SGB-2-	10.4	0.41	2.0	0.08	16.0	0.63
SGB-4-	13.7	0.54	2.0	0.08	20.6	0.81
SGB-6-	17.3	0.68	2.0	0.08	23.9	0.94
SGB-8-	21.6	0.85	2.5	0.10	28.7	1.13
SGB-12-	27.2	1.06	2.5	0.10	35.1	1.38
SGB-16-	33.8	1.33	2.5	0.10	42.9	1.69
SGB-20-	42.4	1.67	2.5	0.10	51.05	2.01
SGB-24-	48.8	1.92	2.5	0.10	59.18	2.33

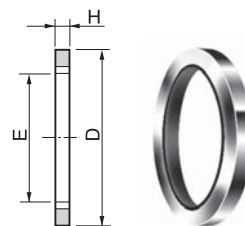

A metal gasket performs the sealing between the reverse bevel of the fitting and the face of the female threaded component.

#### SGC Copper Gasket

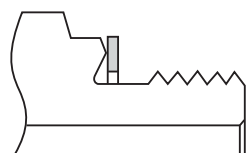

Sealing by gasket (washer)  
Reference DIN 3852 Type B

Ordering Number	E		H		D	
	(mm)	(in.)	(mm)	(in.)	(mm)	(in.)
SGC-2-	10	0.39	2.0	0.08	18	0.71
SGC-4-	14	0.55	2.0	0.08	22	0.86
SGC-6-	17	0.67	2.0	0.08	26	1.02
SGC-8-	22	0.86	2.0	0.08	32	1.26
SGC-12-	27	1.06	2.0	0.08	38	1.50
SGC-16-	34	1.34	2.0	0.08	42	1.65
SGC-20-	42.2	1.66	2.0	0.08	49.8	1.96
SGC-24-	48.0	1.89	2.0	0.08	58.4	2.30

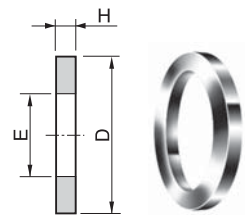

A gasket is dropped into the flat bottom of the female thread. The face of the male thread exerts a load on the gasket to seal.

#### SGG Copper Gasket

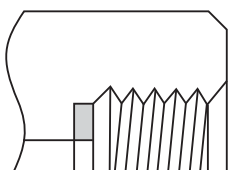

Sealing by gasket.  
Reference DIN 3852 Type Y

Ordering Number	E		H		D	
	(mm)	(in.)	(mm)	(in.)	(mm)	(in.)
SGG-4-	7.6	0.30	1.8	0.07	10.7	0.42
SGG-6-	8.6	0.34	2.3	0.09	14.2	0.56
SGG-8-	9.1	0.36	2.5	0.10	17.8	0.70

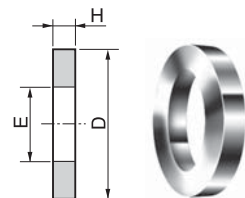



## ISO 7/1

The ISO 7/1 is a tapered thread that is sealing threads working by interference fit. This still requires thread sealant for pressure-tight seal by filling the voids between threads further this prevents galling on piping threads. The sealant usually contains a lubricant.

The ISO 7/1 is described in following codes.

1. BS 21 (BSPT)
2. JIS B0203 (PT)
3. ISO 7/1
4. DIN 2999 (male thread only)

The ISO 7/1 looks similar to the NPT thread. See how different they are as illustrated below.

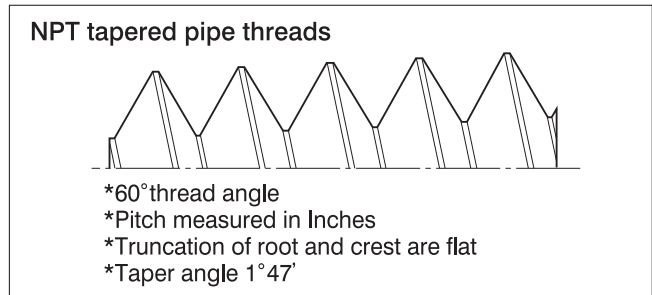
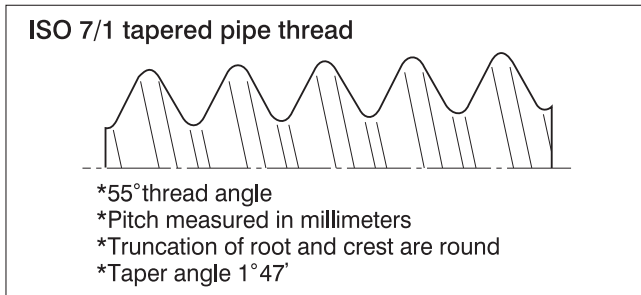

## ISO Internal Parallel Pipe Thread

Diagram	Saehan-LOK Pipe Thread Designator	ISO Female Parallel Pipe Size	Minimum Full Thread Depth L	Thread Minor Diameter D	Minimum Flat Diameter for SGB & SGC C
	2	1/8	0.31	0.337 / 0.348	0.59
	4	1/4	0.47	0.450 / 0.468	0.75
	6	3/8	0.47	0.588 / 0.606	0.91
	8	1/2	0.55	0.733 / 0.755	1.06
	12	3/4	0.63	0.949 / 0.971	1.30
	16	1	0.71	1.193 / 1.218	1.57

## Male Connector for Metal Gasket SOM

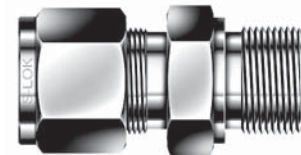
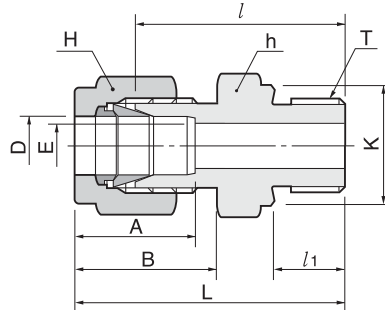

Connects fractional tube to female ISO parallel thread

Part No.	Tube O.D. D		T (PF)	E Min.	Width across flat				A	B	l	l <sub>1</sub>	L	K
	in	mm			h	mm	H	in						
SOM -2-2G	1/8	3.17	1/8	2.28	9/16	14.28	7/16	11.11	12.70	15.24	23.37	7.11	29.97	13.72
SOM -2-4G	1/8	3.17	1/4	2.28	3/4	19.05	7/16	11.11	12.70	15.24	28.70	11.18	35.31	18.03
SOM -2-6G	1/8	3.17	3/8	2.28	7/8	22.22	7/16	11.11	12.70	15.24	29.72	11.18	36.21	21.84
SOM -4-2G	1/4	6.35	1/8	2.28	9/16	14.28	9/16	14.28	15.24	17.78	24.89	7.11	32.26	13.72
SOM -4-4G	1/4	6.35	1/4	4.82	3/4	19.05	9/16	14.28	15.24	17.78	30.23	11.18	37.59	18.03
SOM -4-6G	1/4	6.35	3/8	4.82	7/8	22.22	9/16	14.28	15.24	17.78	31.50	11.18	38.86	21.84
SOM -4-8G	1/4	6.35	1/2	4.82	1-1/16	26.98	9/16	14.28	15.24	17.78	37.34	14.22	44.70	25.91
SOM -6-4G	3/8	9.53	1/4	4.82	3/4	19.05	11/16	17.46	16.76	19.30	31.75	11.18	39.12	18.03
SOM -6-6G	3/8	9.53	3/8	7.11	7/8	22.22	11/16	17.46	16.76	19.30	33.02	11.18	40.39	21.84
SOM -6-8G	3/8	9.53	1/2	7.11	1-1/16	26.98	11/16	17.46	16.76	19.30	38.86	14.22	46.23	25.91
SOM -8-4G	1/2	12.70	1/4	7.11	13/16	20.64	7/8	22.22	22.86	21.84	32.51	11.18	42.67	18.03
SOM -8-6G	1/2	12.70	3/8	9.65	7/8	22.22	7/8	22.22	22.86	21.84	33.02	11.18	43.18	21.84
SOM -8-8G	1/2	12.70	1/2	10.41	1-1/16	26.98	7/8	22.22	22.86	21.84	38.86	14.22	49.02	25.91
SOM -12-8G	3/4	19.05	1/2	11.93	1-1/16	26.98	1-1/8	28.58	24.38	21.84	38.86	14.22	49.02	25.91
SOM -12-12G	3/4	19.05	3/4	15.74	1-5/16	33.33	1-1/8	28.58	24.38	21.84	42.67	15.75	52.83	32.00
SOM -16-8G	1	25.40	1/2	11.93	1-3/8	34.92	1-1/2	38.10	31.24	26.41	43.69	14.22	55.88	25.91
SOM -16-16G	1	25.40	1	22.35	1-5/8	41.27	1-1/2	38.10	31.24	26.41	47.75	18.29	59.94	39.12
SOM -20-20G	1-1/4	31.75	1-1/4	27.68	2	50.80	1-7/8	47.63	41.14	38.86	51.16	20.00	73.26	49.00
SOM -24-24G	1-1/2	38.10	1-1/2	34.03	2-1/4	57.15	2-1/4	57.15	50.03	45.21	57.57	22.00	84.75	55.00

## Male Connector for Metal Gasket SOM

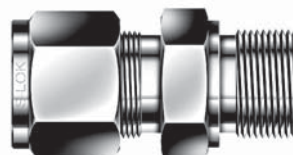
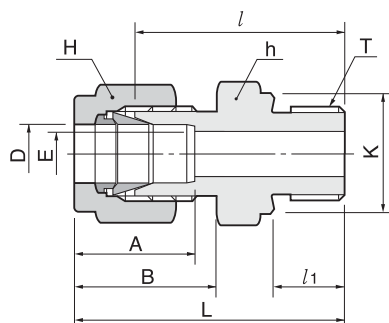

Connects metric tube to female ISO parallel thread

Part No.	Tube O.D. D	T G(PF)	E Min.	Width across flat		A	B	l	l <sub>1</sub>	L	K
				h	H						
SOM-3M-2G	3	1/8	2.4	14	12	12.9	15.3	23.4	7.1	30.0	13.8
SOM-3M-4G	3	1/4	2.4	19	12	12.9	15.3	28.7	11.2	35.3	18.0
SOM-4M-2G	4	1/8	2.4	14	12	13.7	16.1	24.1	7.1	30.7	13.8
SOM-6M-2G	6	1/8	4.0	14	14	15.3	17.7	24.9	7.1	32.3	13.8
SOM-6M-4G	6	1/4	4.8	19	14	15.3	17.7	30.2	11.2	37.6	18.0
SOM-6M-6G	6	3/8	4.8	22	14	15.3	17.7	31.5	11.2	38.9	21.8
SOM-6M-8G	6	1/2	4.8	27	14	15.3	17.7	37.3	14.2	44.7	26.0
SOM-8M-2G	8	1/8	4.0	15	16	16.2	18.6	25.7	7.1	33.2	13.8
SOM-8M-4G	8	1/4	6.4	19	16	16.2	18.6	31.0	11.2	38.5	13.8
SOM-8M-6G	8	3/8	6.4	22	16	16.2	18.6	32.3	11.2	39.8	21.8
SOM-8M-8G	8	1/2	6.4	27	16	16.2	18.6	38.1	14.2	45.6	26.0
SOM-10M-4G	10	1/4	5.9	19	19	17.2	19.5	31.8	11.2	39.4	18.0
SOM-10M-6G	10	3/8	7.9	22	19	17.2	19.5	33.0	11.2	40.6	21.8
SOM-10M-8G	10	1/2	7.9	27	19	17.2	19.5	38.9	14.2	46.5	26.0
SOM-12M-4G	12	1/4	5.9	22	22	22.8	22.0	32.5	11.2	42.6	18.0
SOM-12M-6G	12	3/8	7.9	22	22	22.8	22.0	33.0	11.2	43.1	21.8
SOM-12M-8G	12	1/2	9.5	27	22	22.8	22.0	38.9	14.2	49.0	26.0
SOM-12M-12G	12	3/4	9.5	35	22	22.8	22.0	42.7	15.7	52.8	32.0
SOM-15M-8G	15	1/2	11.9	27	25	24.4	22.0	33.9	14.2	49.0	26.0
SOM-16M-6G	16	3/8	7.9	24	25	24.4	22.0	33.8	11.2	43.9	21.8
SOM-16M-8G	16	1/2	11.9	27	25	24.4	22.0	38.9	14.2	49.0	26.0
SOM-18M-8G	18	1/2	11.9	27	30	24.4	22.0	38.9	14.2	49.0	26.0
SOM-18M-12G	18	3/4	15.1	35	30	24.4	22.0	42.7	15.7	52.8	32.0
SOM-20M-8G	20	1/2	11.9	30	32	26.0	22.0	40.4	14.2	50.5	26.0
SOM-20M-12G	20	3/4	15.9	35	32	26.0	22.0	42.7	15.7	52.8	32.0
SOM-22M-12G	22	3/4	15.9	35	32	26.0	22.0	42.7	15.7	52.8	32.0
SOM-22M-16G	22	1	18.3	41	32	26.0	22.0	45.2	18.3	55.3	39.0
SOM-25M-12G	25	3/4	15.9	35	38	31.3	26.5	45.2	15.7	57.5	32.0
SOM-25M-16G	25	1	19.8	41	38	31.3	26.5	47.8	18.3	60.1	39.0
SOM-28M-16G	28	1	19.8	41	46	36.6	36.6	49.3	18.3	70.1	39.0
SOM-28M-20G	28	1-1/4	21.8	50	46	36.6	36.6	53.1	19.8	73.9	49.0
SOM-32M-20G	32	1-1/4	28.6	50	50	42.0	41.6	55.9	19.8	78.9	49.0
SOM-38M-24G	38	1-1/2	31.8	55	60	49.4	47.9	61.7	20.6	89.3	54.7

**Bulkhead Male Connector  
SMCB**

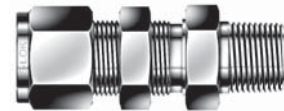
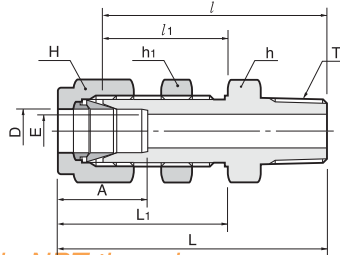

Connects fractional tube to female NPT thread

Part No.	Tube O.D. D		T (NPT)	E Min.	Width across flat			A	l	l1	L	L1	Panel Hole Drill size	Panel Max Thickness			
	in	mm			h	h1	H										
SMCB - 2-2N	1/8	3.17	1/8	2.28	1/2	12.70	1/2	12.70	7/16	11.11	12.70	39.87	24.63	46.48	31.24	8.33	12.70
SMCB - 4-2N	1/4	6.35	1/8	4.82	5/8	15.87	5/8	15.87	9/16	14.28	15.24	42.16	26.16	49.53	33.52	11.50	10.16
SMCB - 4-4N	1/4	6.35	1/4	4.82	5/8	15.87	5/8	15.87	9/16	14.28	15.24	45.97	26.16	53.34	33.52	11.50	10.16
SMCB - 6-4N	3/8	9.52	1/4	7.11	3/4	19.05	3/4	19.05	11/16	17.46	16.76	50.03	29.46	57.40	36.83	14.68	11.17
SMCB - 6-6N	3/8	9.52	3/8	7.11	3/4	19.05	3/4	19.05	11/16	17.46	16.76	50.03	29.46	57.40	36.83	14.68	11.17
SMCB - 6-8N	3/8	9.52	1/2	7.11	7/8	22.22	3/4	19.05	11/16	17.46	16.76	56.38	29.46	63.75	36.83	14.68	11.17
SMCB - 8-6N	1/2	12.70	3/8	9.39	15/16	23.81	15/16	23.81	7/8	22.22	22.86	53.08	31.75	63.24	41.91	19.44	12.70
SMCB - 8-8N	1/2	12.70	1/2	10.41	15/16	23.81	15/16	23.81	7/8	22.22	22.86	58.67	31.75	68.83	41.91	19.44	12.70
SMCB - 12-12N	3/4	19.05	3/4	15.74	1-3/16	30.16	1-3/16	30.16	1-1/8	28.58	24.38	66.04	37.33	76.20	47.49	25.76	16.76
SMCB - 16-16N	1	25.40	1	22.35	1-5/8	41.28	1-5/8	41.28	1-1/2	38.10	31.24	81.02	45.21	93.21	57.40	33.73	19.05
SMCB - 20-20N	1-1/4	31.75	1-1/4	27.68	1-7/8	47.63	1-7/8	47.63	1-7/8	47.63	41.14	85.97	47.75	108.07	69.85	41.67	19.05
SMCB - 24-24N	1-1/2	38.10	1-1/2	34.03	2-1/4	57.15	2-1/4	57.15	2-1/4	57.15	50.03	93.03	49.27	120.21	76.45	49.61	19.05
SMCB - 32-32N	2	50.80	2	45.97	2-3/4	69.85	2-3/4	69.85	3	76.20	67.56	107.29	56.38	144.62	93.71	16.27	19.05

**45° Male Elbow  
SLBM**

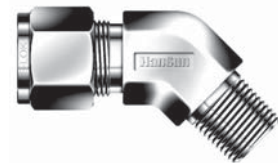
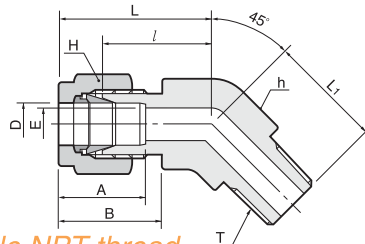

Connects fractional tube to female NPT thread

Part No.	Tube O.D. D		T (NPT)	E Min.	Width across flat			A	B	l	L	L1	
	in	mm			h	h1	H						
SLBM-4-2N	1/4	6.35	1/8	4.82	1/2	12.70	9/16	14.28	15.24	17.78	17.27	24.63	16.51
SLBM-4-4N	1/4	6.35	1/4	4.82	1/2	12.70	9/16	14.28	15.24	17.78	17.27	24.63	21.08
SLBM-6-2N	3/8	9.52	1/8	4.82	5/8	15.87	11/16	17.46	16.76	19.30	20.57	27.94	18.28
SLBM-6-4N	3/8	9.52	1/4	7.11	5/8	15.87	11/16	17.46	16.76	19.30	20.57	27.94	22.86
SLBM-6-6N	3/8	9.52	3/8	7.11	11/16	17.46	11/16	17.46	16.76	19.30	21.84	29.21	24.13
SLBM-8-6N	1/2	12.70	3/8	9.65	13/16	20.64	7/8	22.22	22.86	21.84	21.84	32.00	24.13
SLBM-8-8N	1/2	12.70	1/2	10.41	13/16	20.64	7/8	22.22	22.86	21.84	21.84	32.00	28.95
SLBM-12-12N	3/4	19.05	3/4	15.74	1-1/16	26.98	1-1/8	28.58	24.38	21.84	23.87	34.03	30.98
SLBM-16-16N	1	25.40	1	22.35	1-3/8	34.93	1-1/2	38.10	31.24	26.41	28.19	40.38	37.84

# S-LOK Tube Fittings

## Male Elbow SLM

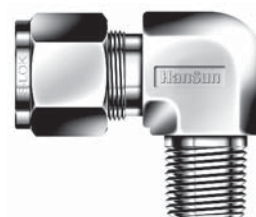
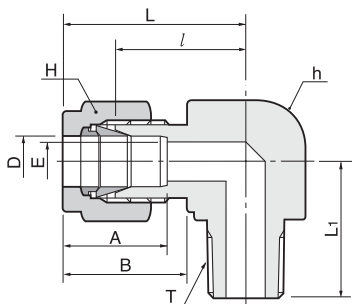

Connects fractional tube to female NPT thread

Part No.	Tube O.D.		T (NPT)	E Min.	Width across flat				A	B	l	L	L <sub>1</sub>
	D				h		H						
	in	mm			in	mm	in	mm					
SLM - 1-1N	1/16	1.59	1/16	1.27	7/16	11.11	5/16	7.93	8.63	10.92	15.24	19.05	17.78
SLM - 1-2N	1/16	1.59	1/8	1.27	7/16	11.11	5/16	7.93	8.63	10.92	15.24	19.05	17.78
SLM - 2-2N	1/8	3.17	1/8	2.28	1/2	12.70	7/16	11.11	12.70	15.24	18.30	24.91	18.90
SLM - 2-4N	1/8	3.17	1/4	2.28	1/2	12.70	7/16	11.11	12.70	15.24	18.30	24.91	23.36
SLM - 3-2N	3/16	4.76	1/8	3.04	1/2	12.70	1/2	12.70	13.71	16.00	18.79	25.40	18.79
SLM - 3-4N	3/16	4.76	1/4	3.04	1/2	12.70	1/2	12.70	13.71	16.00	18.79	25.40	23.36
SLM - 4-1N	1/4	6.35	1/16	3.04	1/2	12.70	9/16	14.28	15.24	17.78	19.55	26.90	18.79
SLM - 4-2N	1/4	6.35	1/8	4.82	1/2	12.70	9/16	14.28	15.24	17.78	19.10	26.47	19.10
SLM - 4-4N	1/4	6.35	1/4	4.82	1/2	12.70	9/16	14.28	15.24	17.78	19.81	27.18	23.87
SLM - 4-6N	1/4	6.35	3/8	4.82	11/16	17.46	9/16	14.28	15.24	17.78	22.35	29.71	26.20
SLM - 4-8N	1/4	6.35	1/2	4.82	13/16	20.64	9/16	14.28	15.24	17.78	24.60	31.97	33.02
SLM - 5-2N	5/16	7.93	1/8	4.82	9/16	14.28	5/8	15.87	16.25	18.54	21.33	28.70	19.81
SLM - 5-4N	5/16	7.93	1/4	6.35	9/16	14.28	5/8	15.87	16.25	18.54	21.33	29.77	24.50
SLM - 5-6N	5/16	7.93	3/8	6.35	11/16	17.46	5/8	15.87	16.25	18.54	23.11	30.48	26.20
SLM - 6-2N	3/8	9.52	1/8	4.82	5/8	15.87	11/16	17.46	16.76	19.30	23.11	30.48	20.60
SLM - 6-4N	3/8	9.52	1/4	7.11	5/8	15.87	11/16	17.46	16.76	19.30	23.11	30.48	25.40
SLM - 6-6N	3/8	9.52	3/8	7.11	11/16	17.46	11/16	17.46	16.76	19.30	23.87	31.24	26.20
SLM - 6-8N	3/8	9.52	1/2	7.11	13/16	20.64	11/16	17.46	16.76	19.30	25.90	31.42	33.02
SLM - 6-12N	3/8	9.52	3/4	7.11	1-1/16	26.98	11/16	17.46	16.76	19.30	29.71	37.08	36.83
SLM - 8-4N	1/2	12.70	1/4	7.11	13/16	20.64	7/8	22.22	22.86	21.84	25.90	36.06	28.30
SLM - 8-6N	1/2	12.70	3/8	9.65	13/16	20.64	7/8	22.22	22.86	21.84	25.90	36.06	28.30
SLM - 8-8N	1/2	12.70	1/2	10.41	13/16	20.64	7/8	22.22	22.86	21.84	25.90	36.06	33.02
SLM - 8-12N	1/2	12.70	3/4	10.41	1-1/16	26.98	7/8	22.22	22.86	21.84	29.71	39.87	36.83
SLM - 10-6N	5/8	15.87	3/8	9.65	15/16	23.81	1	25.40	24.38	21.84	28.00	37.06	30.22
SLM - 10-8N	5/8	15.87	1/2	11.93	15/16	23.81	1	25.40	24.38	21.84	28.00	37.06	35.10
SLM - 10-12N	5/8	15.87	3/4	12.70	1-1/16	26.98	1	25.40	24.38	21.84	29.71	39.87	36.83
SLM - 12-8N	3/4	19.05	1/2	11.93	1-1/16	26.98	1-1/8	28.57	24.38	21.84	29.71	39.87	37.00
SLM - 12-12N	3/4	19.05	3/4	15.74	1-1/16	26.98	1-1/8	28.57	24.38	21.84	29.71	39.87	36.83
SLM - 14-12N	7/8	22.22	3/4	15.74	1-1/4	31.75	1-1/4	31.75	25.90	21.84	34.54	44.70	41.65
SLM - 16-12N	1	25.40	3/4	15.74	1-27-64	36.00	1-1/2	38.10	31.24	26.41	36.83	49.02	42.20
SLM - 16-16N	1	25.40	1	22.35	1-27-64	36.00	1-1/2	38.10	31.24	26.41	36.83	49.02	46.70
SLM - 20-20N	1-1/4	31.75	1-1/4	27.68	1-11/16	42.86	1-7/8	47.63	41.14	38.86	44.50	66.54	47.75
SLM - 24-24N	1-1/2	38.10	1-1/2	34.03	2	50.80	2-1/4	57.15	50.03	45.21	50.80	77.97	60.45
SLM - 32-32N	2	50.80	2	45.97	2-3/4	69.85	3	76.20	62.73	63.73	69.80	107.18	70.61

Male Elbow  
**SLM**

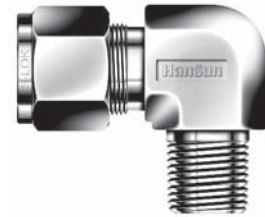
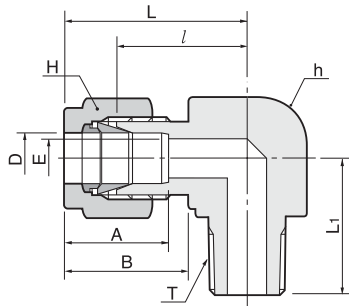

Connects metric tube to female ISO tapered thread

Part No.	Tube O.D.	T R(PT)	E Min.	Width across flat		A	B	l	L	L <sub>1</sub>
	D			h	H					
SLM - 3M-2R	3	1/8	2.4	12.7	12	12.9	15.3	17.0	23.6	17.8
SLM - 3M-4R	3	1/4	2.4	12.7	12	12.9	15.3	18.0	24.6	23.4
SLM - 4M-2R	4	1/8	2.4	12.7	12	13.7	16.1	18.8	25.4	18.8
SLM - 4M-4R	4	1/4	2.4	12.7	12	13.7	16.1	18.8	25.4	23.4
SLM - 6M-2R	6	1/8	4.8	12.7	14	15.3	17.7	19.6	27.0	18.8
SLM - 6M-4R	6	1/4	4.8	12.7	14	15.3	17.7	19.6	27.0	23.4
SLM - 6M-6R	6	3/8	4.8	17.5	14	15.3	17.7	22.4	29.8	26.2
SLM - 6M-8R	6	1/2	4.8	20.6	14	15.3	17.7	24.4	31.8	33.0
SLM - 8M-2R	8	1/8	4.8	14.3	16	16.2	18.6	21.3	28.8	19.8
SLM - 8M-4R	8	1/4	6.4	14.3	16	16.2	18.6	21.3	28.8	24.4
SLM - 8M-6R	8	3/8	6.4	17.5	16	16.2	18.6	23.1	30.6	26.2
SLM - 8M-8R	8	1/2	6.4	20.6	16	16.2	18.6	25.1	32.6	33.0
SLM - 10M-2R	10	1/8	4.8	17.5	19	17.2	19.5	23.9	31.5	23.6
SLM - 10M-4R	10	1/4	7.1	17.5	19	17.2	19.5	23.9	31.5	26.2
SLM - 10M-6R	10	3/8	7.9	17.5	19	17.2	19.5	23.9	31.5	26.2
SLM - 10M-8R	10	1/2	7.9	20.6	19	17.2	19.5	25.9	33.5	33.0
SLM - 12M-2R	12	1/8	4.8	20.6	22	22.8	22.0	25.9	36.0	23.6
SLM - 12M-4R	12	1/4	7.1	20.6	22	22.8	22.0	25.9	36.0	28.2
SLM - 12M-6R	12	3/8	9.5	20.6	22	22.8	22.0	25.9	36.0	28.2
SLM - 12M-8R	12	1/2	9.5	20.6	22	22.8	22.0	25.9	36.0	33.0
SLM - 12M-12R	12	3/4	9.5	27.0	22	22.8	22.0	29.7	39.8	36.8
SLM - 16M-6R	16	3/8	9.5	25.4	25	24.4	22.0	27.9	38.0	30.2
SLM - 16M-8R	16	1/2	11.9	25.4	25	24.4	22.0	27.9	38.0	35.1
SLM - 16M-12R	16	3/4	12.7	27.0	25	24.4	22.0	29.7	39.8	36.8
SLM - 18M-8R	18	1/2	11.9	27.0	30	24.4	22.0	29.7	39.8	36.8
SLM - 18M-12R	18	3/4	15.1	27.0	30	24.4	22.0	29.7	39.8	36.8
SLM - 20M-8R	20	1/2	11.9	31.8	32	26.0	22.0	34.5	44.6	41.7
SLM - 20M-12R	20	3/4	15.9	31.8	32	26.0	22.0	34.5	44.6	41.7
SLM - 22M-12R	22	3/4	15.9	31.8	32	26.0	22.0	34.5	44.6	41.7
SLM - 22M-16R	22	1	18.3	36.0	32	26.0	22.0	34.5	44.6	46.5
SLM - 25M-12R	25	3/4	15.9	36.0	38	31.3	26.5	36.8	49.1	41.7
SLM - 25M-16R	25	1	21.8	36.0	38	31.3	26.5	36.8	49.1	46.5

## Male Run Tee STRM

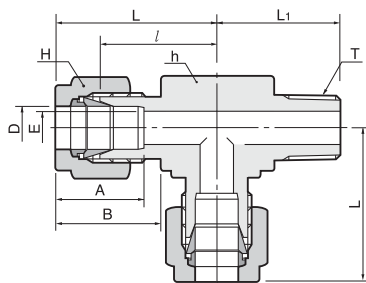

Connects fractional tube to female NPT thread

Part No.	Tube O.D.		T (NPT)	E Min.	Width across flat				A	B	l	L	L1
	in	mm			h	mm	H	mm					
STRM-1-1N	1/16	1.59	1/16	1.27	7/16	11.11	5/16	7.93	8.63	10.92	15.24	19.05	17.78
STRM-1-2N	1/16	1.59	1/8	1.27	7/16	11.11	5/16	7.93	8.63	10.92	15.24	19.05	17.78
STRM-2-2N	1/8	3.17	1/8	2.28	1/2	12.70	7/16	11.11	12.70	15.24	18.30	24.91	18.90
STRM-2-4N	1/8	3.17	1/4	2.28	1/2	12.70	7/16	11.11	12.70	15.24	18.30	24.91	23.36
STRM-3-2N	3/16	4.76	1/8	3.04	1/2	12.70	1/2	12.70	13.71	16.00	18.79	24.38	18.79
STRM-3-4N	3/16	4.76	1/4	3.04	1/2	12.70	1/2	12.70	13.71	16.00	18.79	25.40	23.36
STRM-4-1N	1/4	6.35	1/16	3.04	1/2	12.70	9/16	14.28	15.24	17.78	19.55	26.90	18.79
STRM-4-2N	1/4	6.35	1/8	4.82	1/2	12.70	9/16	14.28	15.24	17.78	19.55	26.92	18.79
STRM-4-4N	1/4	6.35	1/4	4.82	1/2	12.70	9/16	14.28	15.24	17.78	19.55	27.08	23.87
STRM-4-6N	1/4	6.35	3/8	4.82	11/16	17.46	9/16	14.28	15.24	17.78	22.35	29.71	28.40
STRM-4-8N	1/4	6.35	1/2	4.82	13/16	20.64	9/16	14.28	15.24	17.78	24.60	31.97	35.10
STRM-5-2N	5/16	7.93	1/8	4.82	9/16	14.28	5/8	15.87	16.25	18.54	22.35	29.71	19.81
STRM-5-4N	5/16	7.94	1/4	6.35	9/16	14.28	5/8	15.87	16.25	18.54	22.35	29.77	24.50
STRM-5-6N	5/16	7.94	3/8	6.35	11/16	17.46	5/8	15.87	16.25	18.54	23.11	30.48	28.40
STRM-6-4N	3/8	9.52	1/4	7.11	5/8	15.87	1/16	17.46	16.76	19.30	23.11	30.48	25.40
STRM-6-6N	3/8	9.52	3/8	7.11	11/16	17.46	11/16	17.46	16.76	19.30	23.87	31.24	28.44
STRM-6-8N	3/8	9.52	1/2	7.11	13/16	20.64	11/16	17.46	16.76	19.30	25.90	33.27	33.02
STRM-6-12N	3/8	9.52	3/4	7.11	1-1/16	26.98	11/16	17.46	16.76	19.30	29.71	37.08	36.83
STRM-8-4N	1/2	12.70	1/4	7.11	13/16	20.64	7/8	22.22	22.86	21.84	25.90	36.06	28.30
STRM-8-6N	1/2	12.70	3/8	9.65	13/16	20.64	7/8	22.22	22.86	21.84	25.90	36.06	28.30
STRM-8-8N	1/2	12.70	1/2	10.41	13/16	20.64	7/8	22.22	22.86	21.84	25.90	36.06	33.02
STRM-8-12N	1/2	12.70	3/4	10.41	1-1/16	26.98	7/8	22.22	22.86	21.84	29.71	39.84	36.83
STRM-10-6N	5/8	15.87	3/8	9.65	15/16	23.81	1	25.40	24.38	21.84	27.90	38.10	29.40
STRM-10-8N	5/8	15.87	1/2	11.93	15/16	23.81	1	25.40	24.38	21.84	27.90	38.10	34.00
STRM-10-12N	5/8	15.87	3/4	12.70	1-1/16	26.98	1	25.40	24.38	21.84	29.71	39.87	36.83
STRM-12-8N	3/4	19.05	1/2	11.93	1-1/16	26.98	1-1/8	28.58	24.38	21.84	29.71	39.87	37.00
STRM-12-12N	3/4	19.05	3/4	15.74	1-1/16	26.98	1-1/8	28.58	24.38	21.84	29.71	39.81	36.83
STRM-14-12N	7/8	22.23	3/4	15.74	1-1/16	26.98	1-1/4	31.75	25.90	21.84	34.54	44.70	41.65
STRM-16-12N	1	25.40	3/4	15.74	1-1/4	31.75	1-1/2	38.10	31.24	26.41	36.83	49.02	42.20
STRM-16-16N	1	25.40	1	22.35	1-27/64	36.12	1-1/2	38.10	31.24	26.41	36.83	49.02	46.70
STRM-20-20N	1-1/4	31.75	1-1/4	27.68	1-27/64	36.12	1-7/8	47.63	41.14	38.86	44.50	66.54	47.75
STRM-24-24N	1-1/2	38.10	1-1/2	34.03	2	50.80	2-1/4	57.15	50.03	45.21	50.80	77.97	60.45
STRM-32-32N	2	50.80	2	45.97	2-3/4	69.85	3	76.20	67.56	62.73	69.80	107.18	70.61

Male Run Tee  
**STRM**

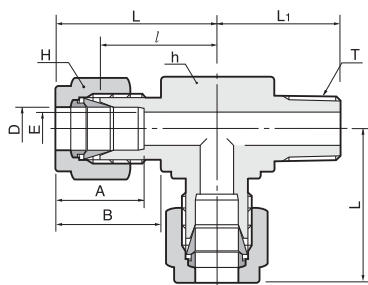

Connects metric tube to female ISO tapered thread

Part No.	Tube O.D. D	T R(PT)	E Min.	Width across flat		A	B	l	L	L <sub>1</sub>
				h	H					
STRM-3M-2R	3	1/8	2.4	12.7	12	12.9	15.3	17.0	23.6	17.8
STRM-3M-4R	3	1/4	2.4	12.7	12	12.9	15.3	18.0	24.6	23.4
STRM-4M-2R	4	1/8	2.4	12.7	12	13.7	16.1	18.8	25.4	18.8
STRM-4M-4R	4	1/4	2.4	12.7	12	13.7	16.1	18.8	25.4	23.4
STRM-6M-2R	6	1/8	4.8	12.7	14	15.3	17.7	19.6	27.0	18.8
STRM-6M-4R	6	1/4	4.8	12.7	14	15.3	17.7	19.6	27.0	23.4
STRM-6M-6R	6	3/8	4.8	17.5	14	15.3	17.7	22.4	29.8	26.2
STRM-6M-8R	6	1/2	4.8	20.6	14	15.3	17.7	24.4	31.8	33.0
STRM-8M-2R	8	1/8	4.8	14.3	16	16.2	18.6	21.3	28.8	19.8
STRM-8M-4R	8	1/4	6.4	14.3	16	16.2	18.6	21.3	28.8	24.4
STRM-8M-6R	8	3/8	6.4	17.5	16	16.2	18.6	23.1	30.6	26.2
STRM-8M-8R	8	1/2	6.4	20.6	16	16.2	18.6	25.1	32.6	33.0
STRM-10M-2R	10	1/8	4.8	17.5	19	17.2	19.5	23.9	31.5	23.6
STRM-10M-4R	10	1/4	7.1	17.5	19	17.2	19.5	23.9	31.5	26.2
STRM-10M-6R	10	3/8	7.9	17.5	19	17.2	19.5	23.9	31.5	26.2
STRM-10M-8R	10	1/2	7.9	20.6	19	17.2	19.5	25.9	33.5	33.0
STRM-12M-2R	12	1/8	4.8	20.6	22	22.8	22.0	25.9	36.0	23.6
STRM-12M-4R	12	1/4	7.1	20.6	22	22.8	22.0	25.9	36.0	28.2
STRM-12M-6R	12	3/8	9.5	20.6	22	22.8	22.0	25.9	36.0	28.2
STRM-12M-8R	12	1/2	9.5	20.6	22	22.8	22.0	25.9	36.0	33.0
STRM-12M-12R	12	3/4	9.5	27.0	22	22.8	22.0	29.7	39.8	36.8
STRM-16M-6R	16	3/8	9.5	25.4	25	24.4	22.0	27.9	38.0	30.2
STRM-16M-8R	16	1/2	11.9	25.4	25	24.4	22.0	27.9	38.0	35.1
STRM-16M-12R	16	3/4	12.7	27.0	25	24.4	22.0	29.7	39.8	36.8
STRM-18M-8R	18	1/2	11.9	27.0	30	24.4	22.0	29.7	39.8	36.8
STRM-18M-12R	18	3/4	15.1	27.0	30	24.4	22.0	29.7	39.8	36.8
STRM-20M-8R	20	1/2	11.9	31.8	32	26.0	22.0	34.5	44.6	41.7
STRM-20M-12R	20	3/4	15.9	31.8	32	26.0	22.0	34.5	44.6	41.7
STRM-22M-12R	22	3/4	15.9	31.8	32	26.0	22.0	34.5	44.6	41.7
STRM-22M-16R	22	1	18.3	36.0	32	26.0	22.0	34.5	44.6	46.5
STRM-25M-12R	25	3/4	15.9	36.0	38	31.3	26.5	36.8	49.1	41.7
STRM-25M-16R	25	1	21.8	36.0	38	31.3	26.5	36.8	49.1	46.5

## Male Branch Tee STBM

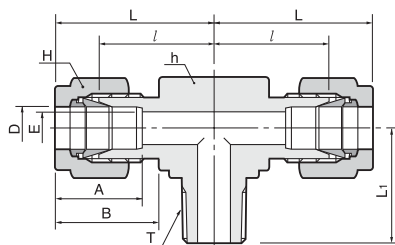

Connects fractional tube to female NPT thread

Part No.	Tube O.D.		T (NPT)	E Min.	Width across flat				A	B	l	L	L <sub>1</sub>
	D				h	H							
	in	mm					in	mm					
STBM-1-1N	1/16	1.59	1/16	1.27	7/16	11.11	5/16	7.93	8.63	10.92	15.24	19.05	17.78
STBM-1-2N	1/16	1.59	1/8	1.27	7/16	11.11	5/16	7.93	8.63	10.92	15.24	19.05	17.78
STBM-2-2N	1/8	3.17	1/8	2.28	1/2	12.70	7/16	11.11	12.70	15.24	18.30	24.91	18.90
STBM-2-4N	1/8	3.17	1/4	2.28	1/2	12.70	7/16	11.11	12.70	15.24	18.30	24.91	23.36
STBM-3-2N	3/16	4.76	1/8	3.04	1/2	12.70	1/2	12.70	13.71	16.00	18.79	24.38	18.79
STBM-3-4N	3/16	4.76	1/4	3.04	1/2	12.70	1/2	12.70	13.71	16.00	18.79	25.40	23.36
STBM-4-1N	1/4	6.35	1/16	3.04	1/2	12.70	9/16	14.28	15.24	17.78	19.55	26.90	18.79
STBM-4-2N	1/4	6.35	1/8	4.82	1/2	12.70	9/16	14.28	15.24	17.78	19.55	26.92	19.10
STBM-4-4N	1/4	6.35	1/4	4.82	1/2	12.70	9/16	14.28	15.24	17.78	19.55	27.08	23.87
STBM-4-6N	1/4	6.35	3/8	4.82	11/16	17.46	9/16	14.28	15.24	17.78	22.35	29.71	28.40
STBM-4-8N	1/4	6.35	1/2	4.82	13/16	20.64	9/16	14.28	15.24	17.78	24.60	31.97	35.10
STBM-5-2N	5/16	7.93	1/8	4.82	9/16	14.28	5/8	15.87	16.25	18.54	22.35	29.71	19.81
STBM-5-4N	5/16	7.93	1/4	6.35	9/16	14.28	5/8	15.87	16.25	18.54	22.35	29.77	24.50
STBM-5-6N	5/16	7.93	3/8	6.35	11/16	17.46	5/8	15.87	16.25	18.54	23.11	30.48	28.40
STBM-6-4N	3/8	9.52	1/4	7.11	5/8	15.87	11/16	17.46	16.76	19.30	23.11	30.48	25.40
STBM-6-6N	3/8	9.52	3/8	7.11	11/16	17.46	11/16	17.46	16.76	19.30	23.87	31.24	28.44
STBM-6-8N	3/8	9.52	1/2	7.11	13/16	20.64	11/16	17.46	16.76	19.30	25.90	33.27	33.02
STBM-6-12N	3/8	9.52	3/4	7.11	1-1/16	26.98	11/16	17.46	16.76	19.30	29.71	37.08	36.83
STBM-8-4N	1/2	12.70	1/4	7.11	13/16	20.64	7/8	22.22	22.86	21.84	25.90	36.06	28.30
STBM-8-6N	1/2	12.70	3/8	10.41	13/16	20.64	7/8	22.22	22.86	21.84	25.90	36.06	28.30
STBM-8-8N	1/2	12.70	1/2	10.41	13/16	20.64	7/8	22.22	22.86	21.84	25.90	36.06	33.02
STBM-8-12N	1/2	12.70	3/4	10.41	1-1/16	26.98	7/8	22.22	22.86	21.84	29.71	39.87	36.83
STBM-10-6N	5/8	15.87	3/8	9.65	15/16	23.81	1	25.40	24.38	21.84	27.90	38.10	29.40
STBM-10-8N	5/8	15.87	1/2	11.93	15/16	23.81	1	25.40	24.38	21.84	27.90	38.10	34.00
STBM-10-12N	5/8	15.87	3/4	12.70	1-1/16	26.98	1	25.40	24.38	21.84	29.71	39.87	36.83
STBM-12-8N	3/4	19.05	1/2	11.93	1-1/16	26.98	1-1/8	28.58	24.38	21.84	29.71	39.87	37.00
STBM-12-12N	3/4	19.05	3/4	15.74	1-1/16	26.98	1-1/8	28.58	24.38	21.84	29.71	39.87	36.83
STBM-14-12N	7/8	22.22	3/4	15.74	1-1/16	26.98	1-1/4	31.75	25.90	21.84	34.54	44.70	41.65
STBM-16-12N	1	25.40	3/4	15.74	1-1/4	31.75	1-1/2	38.10	31.24	26.41	36.83	49.02	42.20
STBM-16-16N	1	25.40	1	22.35	1-27/64	36.12	1-1/2	38.10	31.24	26.41	36.83	49.02	46.70
STBM-20-20N	1-1/4	31.75	1-1/4	27.68	1-27-64	36.12	1-7/8	47.63	41.14	38.86	44.50	66.54	47.75
STBM-24-24N	1-1/2	38.10	1-1/2	34.03	2	50.80	2-1/4	57.15	50.03	45.21	50.80	77.97	60.45
STBM-32-32N	2	50.80	2	45.97	2-3/4	69.85	3	76.20	67.56	62.73	69.80	107.18	70.61



Male Branch Tee  
**STBM**

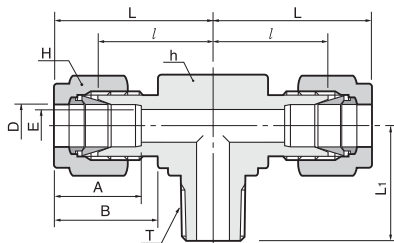

Connects metric tube to female ISO tapered thread

Part No.	Tube O.D.	T R(PT)	E Min.	Width across flat		A	B	l	L	L <sub>1</sub>
	D			h	H					
STBM - 3M-2R	3	1/8	2.4	12.7	12	12.9	15.3	17.0	23.6	17.8
STBM - 3M-4R	3	1/4	2.4	12.7	12	12.9	15.3	18.0	24.6	23.4
STBM - 4M-2R	4	1/8	2.4	12.7	12	13.7	16.1	18.8	25.4	18.8
STBM - 4M-4R	4	1/4	2.4	12.7	12	13.7	16.1	18.8	25.4	23.4
STBM - 6M-2R	6	1/8	4.8	12.7	14	15.3	17.7	19.6	27.0	18.8
STBM - 6M-4R	6	1/4	4.8	14.2	14	15.3	17.7	19.6	27.0	23.4
STBM - 6M-6R	6	3/8	4.8	17.5	14	15.3	17.7	22.4	29.8	26.2
STBM - 6M-8R	6	1/2	4.8	20.6	14	15.3	17.7	24.4	31.8	33.0
STBM - 8M-2R	8	1/8	4.8	14.3	16	16.2	18.6	21.3	28.8	19.8
STBM - 8M-4R	8	1/4	6.4	14.3	16	16.2	18.6	21.3	28.8	24.4
STBM - 8M-6R	8	3/8	6.4	17.5	16	16.2	18.6	23.1	30.6	26.2
STBM - 8M-8R	8	1/2	6.4	20.6	16	16.2	18.6	25.1	32.6	33.0
STBM - 10M-2R	10	1/8	4.8	17.5	19	17.2	19.5	23.9	31.5	23.6
STBM - 10M-4R	10	1/4	7.1	17.5	19	17.2	19.5	23.9	31.5	26.2
STBM - 10M-6R	10	3/8	7.9	17.5	19	17.2	19.5	23.9	31.5	26.2
STBM - 10M-8R	10	1/2	7.9	20.6	19	17.2	19.5	25.9	33.5	33.0
STBM - 12M-2R	12	1/8	4.8	20.6	22	22.8	22.0	25.9	36.0	23.6
STBM - 12M-4R	12	1/4	7.1	20.6	22	22.8	22.0	25.9	36.0	28.2
STBM - 12M-6R	12	3/8	9.5	20.6	22	22.8	22.0	25.9	36.0	28.2
STBM - 12M-8R	12	1/2	9.5	20.6	22	22.8	22.0	25.9	36.0	33.0
STBM - 12M-12R	12	3/4	9.5	27.0	22	22.8	22.0	29.7	39.8	36.8
STBM - 16M-6R	16	3/8	9.5	25.4	25	24.4	22.0	27.9	38.0	30.2
STBM - 16M-8R	16	1/2	11.9	25.4	25	24.4	22.0	27.9	38.0	35.1
STBM - 16M-12R	16	3/4	12.7	27.0	25	24.4	22.0	29.7	39.8	36.8
STBM - 18M-8R	18	1/2	11.9	27.0	30	24.4	22.0	29.7	39.8	36.8
STBM - 18M-12R	18	3/4	15.1	27.0	30	24.4	22.0	29.7	39.8	36.8
STBM - 20M-8R	20	1/2	11.9	31.8	32	26.0	22.0	34.5	44.6	41.7
STBM - 20M-12R	20	3/4	15.9	31.8	32	26.0	22.0	34.5	44.6	41.7
STBM - 22M-12R	22	3/4	15.9	31.8	32	26.0	22.0	34.5	44.6	41.7
STBM - 22M-16R	22	1	18.3	36.0	32	26.0	22.0	34.5	44.6	46.5
STBM - 25M-12R	25	3/4	15.9	36.0	38	31.3	26.5	36.8	49.1	41.7
STBM - 25M-16R	25	1	21.8	36.0	38	31.3	26.5	36.8	49.1	46.5

# S-LOK Tube Fittings

## Female Connector SCF

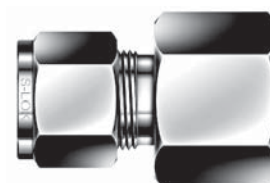
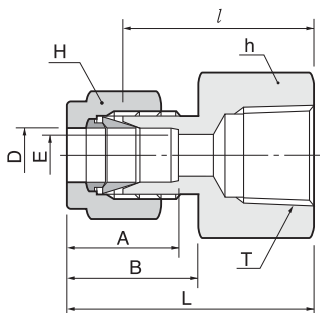

Connects fractional tube to male NPT thread

Part No.	Tube O.D. D		T (NPT)	E Min.	Width across flat				A	B	l	L
	in	mm			h		H					
SCF - 1-1N	1/16	1.59	1/16	1.27	7/16	11.11	5/16	7.93	8.63	10.92	19.81	23.62
SCF - 1-2N	1/16	1.59	1/8	1.27	9/16	14.28	5/16	7.93	8.63	10.92	20.57	24.38
SCF - 2-2N	1/8	3.17	1/8	2.28	9/16	14.28	7/16	11.11	12.70	15.24	22.09	28.70
SCF - 2-4N	1/8	3.17	1/4	2.28	3/4	19.05	7/16	11.11	12.70	15.24	26.92	33.52
SCF - 3-2N	3/16	4.76	1/8	3.04	9/16	14.28	1/2	12.70	13.71	16.00	23.11	29.71
SCF - 4-2N	1/4	6.35	1/8	4.82	9/16	14.28	9/16	14.28	15.24	17.78	23.87	31.24
SCF - 4-4N	1/4	6.35	1/4	4.82	3/4	19.05	9/16	14.28	15.24	17.78	28.44	35.81
SCF - 4-6N	1/4	6.35	3/8	4.82	7/8	22.22	9/16	14.28	15.24	17.78	30.22	37.59
SCF - 4-8N	1/4	6.35	1/2	4.82	1-1/16	26.98	9/16	14.28	15.24	17.78	35.05	42.41
SCF - 5-2N	5/16	7.93	1/8	6.35	9/16	14.28	5/8	15.87	16.25	18.54	24.63	32.00
SCF - 5-4N	5/16	7.93	1/4	6.35	3/4	19.05	5/8	15.87	16.25	18.54	29.46	36.83
SCF - 6-2N	3/8	9.52	1/8	7.11	5/8	15.87	11/16	17.46	16.76	19.30	25.40	32.76
SCF - 6-4N	3/8	9.52	1/4	7.11	3/4	19.05	11/16	17.46	16.76	19.30	30.22	37.59
SCF - 6-6N	3/8	9.52	3/8	7.11	7/8	22.22	11/16	17.46	16.76	19.30	31.75	39.11
SCF - 6-8N	3/8	9.52	1/2	7.11	1-1/16	26.98	11/16	17.46	16.76	19.30	36.57	43.94
SCF - 6-12N	3/8	9.52	3/4	7.11	1-5/16	33.33	11/16	17.46	16.76	19.30	40.38	47.75
SCF - 8-4N	1/2	12.70	1/4	10.41	1-3/16	20.64	7/8	22.22	22.86	21.84	30.22	40.38
SCF - 8-6N	1/2	12.70	3/8	10.41	7/8	22.22	7/8	22.22	22.86	21.84	31.75	41.91
SCF - 8-8N	1/2	12.70	1/2	10.41	1-1/16	26.98	7/8	22.22	22.86	21.84	36.57	46.73
SCF - 8-12N	1/2	12.70	3/4	10.41	1-5/16	33.33	7/8	22.22	22.86	21.84	38.10	48.26
SCF - 10-6N	5/8	15.87	3/8	12.70	15/16	23.81	1	25.40	24.38	21.84	31.75	41.91
SCF - 10-8N	5/8	15.87	1/2	12.70	1-1/16	26.98	1	25.40	24.38	21.84	36.57	46.73
SCF - 10-12N	5/8	15.87	3/4	12.70	1-5/16	33.33	1	25.40	24.38	21.84	38.10	48.26
SCF - 12-8N	3/4	19.05	1/2	15.74	1-1/16	26.98	1-1/8	28.58	24.38	21.84	36.57	46.73
SCF - 12-12N	3/4	19.05	3/4	15.74	1-5/16	33.33	1-1/8	28.58	24.38	21.84	38.10	48.26
SCF - 14-12N	7/8	22.22	3/4	18.28	1-5/16	33.33	1-1/4	31.75	25.90	21.84	39.62	49.78
SCF - 16-12N	1	25.40	3/4	22.35	1-3/8	34.92	1-1/2	38.10	31.24	26.41	41.14	53.34
SCF - 16-16N	1	25.40	1	22.35	1-5/8	41.27	1-1/2	38.10	31.24	26.41	50.03	62.23
SCF - 20-20N	1-1/4	31.75	1-1/4	27.68	2-1/8	53.98	1-7/8	47.63	41.14	38.86	52.57	74.67
SCF - 24-24N	1-1/2	38.10	1-1/2	34.03	2-3/8	60.33	2-1/4	57.15	50.03	45.21	56.13	83.31
SCF - 32-32N	2	50.80	2	45.97	2-1/8	73.03	3	76.20	67.56	62.73	64.26	101.60

## Female Connector SCF

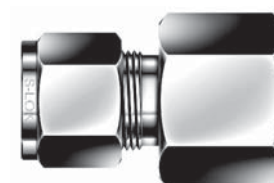
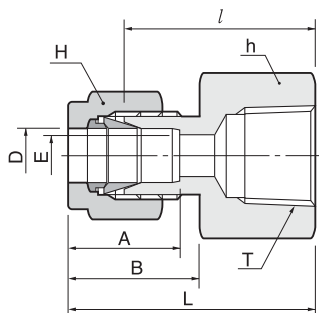

Connects metric tube to male ISO tapered thread

Part No.	Tube O.D. D	T R(PT)	E Min.	Width across flat		A	B	l	L
				h	H				
SCF - 3M-2R	3	1/8	2.4	14	12	12.9	15.3	22.1	28.7
SCF - 3M-4R	3	1/4	2.4	19	12	12.9	15.3	26.9	33.5
SCF - 4M-2R	4	1/8	2.4	14	12	13.7	16.1	23.1	29.7
SCF - 6M-2R	6	1/8	4.8	14	14	15.3	17.7	23.9	31.3
SCF - 6M-4R	6	1/4	4.8	19	14	15.3	17.7	28.4	35.8
SCF - 6M-6R	6	3/8	4.8	22	14	15.3	17.7	29.5	36.9
SCF - 6M-8R	6	1/2	4.8	27	14	15.3	17.7	35.1	42.5
SCF - 8M-2R	8	1/8	6.4	15	16	16.2	18.6	24.6	32.1
SCF - 8M-4R	8	1/4	6.4	19	16	16.2	18.6	29.5	37.0
SCF - 8M-6R	8	3/8	6.4	22	16	16.2	18.6	30.2	37.7
SCF - 8M-8R	8	1/2	6.4	27	16	16.2	18.6	35.8	43.3
SCF - 10M-2R	10	1/8	7.9	18	19	17.2	19.5	25.4	33.0
SCF - 10M-4R	10	1/4	7.9	19	19	17.2	19.5	30.2	37.8
SCF - 10M-6R	10	3/8	7.9	22	19	17.2	19.5	31.0	38.6
SCF - 10M-8R	10	1/2	7.9	27	19	17.2	19.5	36.6	44.2
SCF - 12M-2R	12	1/8	8.3	22	22	22.8	22.0	28.4	38.5
SCF - 12M-4R	12	1/4	9.5	22	22	22.8	22.0	30.2	40.3
SCF - 12M-6R	12	3/8	9.5	22	22	22.8	22.0	31.0	41.1
SCF - 12M-8R	12	1/2	9.5	27	22	22.8	22.0	36.6	46.7
SCF - 12M-12R	12	3/4	9.5	35	22	22.8	22.0	38.9	49.0
SCF - 15M-8R	15	1/2	11.9	27	25	24.4	22.0	36.6	46.7
SCF - 16M-8R	16	1/2	12.7	27	25	24.4	22.0	36.8	46.9
SCF - 20M-8R	20	1/2	15.9	30	32	26.0	22.0	37.8	47.9
SCF - 20M-12R	20	3/4	15.9	35	32	26.0	22.0	39.6	49.7
SCF - 22M-12R	22	3/4	18.3	35	32	26.0	22.0	39.6	49.7
SCF - 22M-16R	22	1	18.3	41	32	26.0	22.0	47.8	57.9
SCF - 25M-12R	25	3/4	21.8	35	38	31.3	26.5	41.1	53.4
SCF - 25M-16R	25	1	21.8	41	38	31.3	26.5	50.0	62.3

# S-LOK Tube Fittings

## Gauge Connector SCG

See page 24  
for SGG gasket

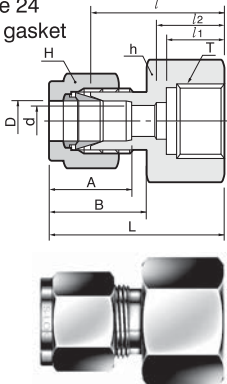

Connects metric tube to ISO parallel thread (gauge)

Part No.	Tube O.D.		T	E	Width across flat			A	B	l	l <sub>1</sub>	l <sub>2</sub>	d	L
	D	R(PF)			h	H	Min.							
SCG-3M-4G	3	1/4	2.4	19	12	12.9	15.3	28.7	13	17.0	5.5	35.3		
SCG-6M-4G	6	1/4	4.8	19	14	15.3	17.7	30.2	13	17.0	5.5	37.6		
SCG-6M-6G	6	3/8	4.8	24	14	15.3	17.7	30.2	14	20.3	6.5	37.6		
SCG-6M-8G	6	1/2	4.8	27	14	15.3	17.7	36.1	19	24.9	7.0	43.5		
SCG-8M-4G	8	1/4	5.5	19	16	16.2	18.6	31.0	13	-	5.5	38.5		
SCG-8M-6G	8	3/8	6.5	24	16	16.2	18.6	28.7	14	-	6.5	36.2		
SCG-8M-8G	8	1/2	7.0	27	16	16.2	18.6	33.5	19	-	7.0	41.0		
SCG-10M-4G	10	1/4	5.5	19	19	17.2	19.5	31.8	13	-	5.5	39.4		
SCG-10M-6G	10	3/8	6.5	24	19	17.2	19.5	31.2	14	-	6.5	38.8		
SCG-10M-8G	10	1/2	7.0	27	19	17.2	19.5	34.5	19	-	7.0	42.1		
SCG-12M-4G	12	1/4	5.5	22	22	22.8	22.0	31.8	13	-	5.5	41.9		
SCG-12M-6G	12	3/8	6.5	24	22	22.8	22.0	34.3	14	-	6.5	44.4		
SCG-12M-8G	12	1/2	7.0	27	22	22.8	22.0	38.1	19	-	7.0	48.2		
SCG-20M-8G	20	1/2	7.0	30	32	26.0	22.0	44.2	19	-	7.0	54.3		
SCG-22M-8G	22	1/2	7.0	30	32	26.0	22.0	44.2	19	-	7.0	54.3		

Connects fractional tube to ISO parallel thread (gauge)

Part No.	Tube O.D.		T	E	Width across flat			A	B	l	l <sub>1</sub>	l <sub>2</sub>	d	L	
	D	in			mm	G(PF)	Min.								h
SCG - 4-2G	1/4	6.35	1/8	4.82	9/16	14.28	9/16	14.28	15.24	17.78	26.30	12.00	17.0	5.6	33.55
SCG - 4-4G	1/4	6.35	1/4	4.82	3/4	19.05	9/16	14.28	15.24	17.78	30.22	12.95	17.0	5.6	37.59
SCG - 4-6G	1/4	6.35	3/8	4.82	15/16	24.81	9/16	14.28	15.24	17.78	30.22	14.22	20.3	6.6	37.59
SCG - 4-8G	1/4	6.35	1/2	4.82	1-1/16	26.96	9/16	14.28	15.24	17.78	36.07	18.80	24.9	7.1	43.43
SCG - 5-4G	5/16	7.93	1/4	5.58	3/4	19.05	5/8	15.87	16.25	18.54	30.98	12.95	-	-	38.6
SCG - 5-8G	5/16	7.93	1/2	7.11	1-1/16	26.98	5/8	15.87	16.25	18.54	33.53	18.80	-	-	40.89
SCG - 6-4G	3/8	9.52	1/4	5.58	3/4	19.05	11/16	17.46	16.76	19.30	31.75	12.95	-	-	39.12
SCG - 6-6G	3/8	9.52	3/8	6.60	15/16	24.81	11/16	17.46	16.76	19.30	31.24	14.22	-	-	38.61
SCG - 6-8G	3/8	9.52	1/2	7.11	1-1/16	26.98	11/16	17.46	16.76	19.30	34.54	18.80	-	-	41.91
SCG - 8-4G	1/2	12.70	1/4	5.50	7/8	22.22	7/8	22.22	22.86	21.84	31.80	12.95	-	-	41.95
SCG - 8-6G	1/2	12.70	3/8	6.60	15/16	23.81	7/8	22.22	22.86	21.84	34.29	14.22	-	-	44.45
SCG - 8-8G	1/2	12.70	1/2	7.11	1-1/16	26.98	7/8	22.22	22.86	21.84	38.10	18.80	-	-	48.26

## Bulkhead Female Connector SCBF

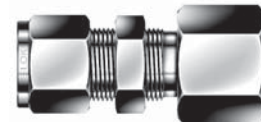
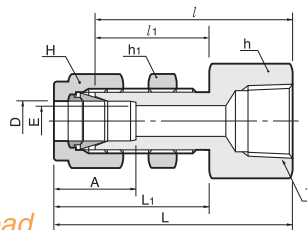

Connects fractional tube to male NPT thread

Part No.	Tube O.D.		T	E	Width across flat			A	l	l <sub>1</sub>	L	L <sub>1</sub>	Panel Hole Drill Size	Panel Max Thickness			
	D	in			mm	(NPT)	Min.								h	h <sub>1</sub>	H
SCBF - 2-2N	1/8	3.17	1/8	2.28	9/16	14.28	1/2	12.70	7/16	11.11	12.70	38.10	24.63	44.70	31.24	8.33	12.70
SCBF - 4-2N	1/4	6.35	1/8	4.82	5/8	15.87	5/8	15.87	9/16	14.28	15.24	39.62	26.16	46.99	33.52	11.50	10.16
SCBF - 4-4N	1/4	6.35	1/4	4.82	3/4	19.05	5/8	15.87	9/16	14.28	15.24	44.45	26.16	51.81	33.52	11.50	10.16
SCBF - 6-4N	3/8	9.52	1/4	7.11	3/4	19.05	3/4	19.05	11/16	17.46	16.76	47.75	29.46	55.11	36.83	14.68	11.17
SCBF - 6-6N	3/8	9.52	3/8	7.11	7/8	22.22	3/4	19.05	11/16	17.46	16.76	49.41	29.46	56.77	36.83	14.68	11.17
SCBF - 8-6N	1/2	12.70	3/8	10.41	15/16	23.81	15/16	23.81	7/8	22.22	22.86	51.56	31.75	61.72	41.91	19.44	12.70
SCBF - 8-8N	1/2	12.70	1/2	10.41	1-1/16	26.98	15/16	23.81	7/8	22.22	22.86	56.38	31.75	66.54	41.91	19.44	12.70
SCBF - 12-12N	3/4	19.05	3/4	15.74	1-1/4	31.75	1-3/16	30.16	1-1/8	28.57	24.38	63.60	37.33	73.51	47.21	25.79	16.76
SCBF - 16-16N	1	25.40	1	22.35	1-5/8	41.27	1-5/8	41.27	1-1/2	38.10	31.24	81.04	45.21	93.23	57.40	33.73	19.05
SCBF - 20-20N	1-1/4	31.75	1-1/4	27.68	1-7/8	47.63	1-7/8	47.63	1-7/8	47.63	41.14	83.49	47.75	105.59	69.85	41.67	19.05
SCBF - 24-24N	1-1/2	38.10	1-1/2	34.03	1-1/4	57.15	2-1/4	57.15	2-1/4	57.15	50.03	87.39	49.27	114.57	76.45	49.61	19.05
SCBF - 32-32N	2	50.80	2	45.97	1-3/4	69.85	2-3/4	69.85	3	76.20	67.56	95.30	56.38	132.63	93.71	57.94	19.05

Connects metric tube to male NPT thread

Part No.	Tube O.D.		T	E	Width across flat			A	l	l <sub>1</sub>	L	L <sub>1</sub>	Panel Hole Drill Size	Panel Max Thickness
	D	(NPT)			Min.	h	h <sub>1</sub>							
SCBF - 6M-2N	6	1/8	4.8	15.8	15.8	14	15.3	39.6	26.2	46.90	35.00	11.5	10.2	
SCBF - 6M-4N	6	1/4	4.8	19.0	16.0	14	15.3	44.4	26.2	51.80	33.60	11.5	10.2	
SCBF - 8M-4N	8	1/4	6.3	19.0	17.4	16	16.2	46.7	28.6	53.85	35.55	13.1	11.2	
SCBF - 12M-8N	12	1/2	9.5	27.0	24.0	22	22.8	56.4	31.8	66.50	41.90	19.5	12.7	

Female Elbow  
SLF

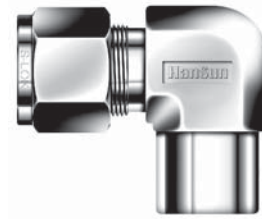
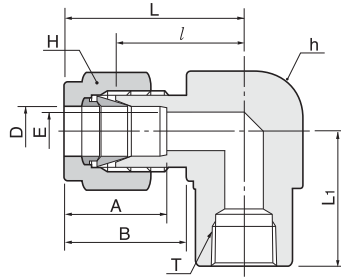

Connects fractional tube to male NPT thread

Part No.	Tube O.D. D		T (NPT)	E Min.	Width across flat		A	B	l	L	L <sub>1</sub>		
	in	mm			h	H							
SLF-2-2N	1/8	3.17	1/8	2.28	1/2	12.70	7/16	11.11	12.70	15.24	18.03	24.63	19.05
SLF-2-4N	1/8	3.17	1/4	2.28	11/16	17.46	7/16	11.11	12.70	15.24	20.82	27.43	22.35
SLF-3-2N	3/16	4.76	1/8	3.04	1/2	12.70	1/2	12.70	13.71	16.00	18.79	25.40	19.05
SLF-4-2N	1/4	6.35	1/8	4.82	1/2	12.70	9/16	14.28	15.24	17.78	19.55	26.92	19.05
SLE-4-4N	1/4	6.35	1/4	4.82	11/16	17.46	9/16	14.28	15.24	17.78	22.35	29.71	22.35
SLF-4-6N	1/4	6.35	3/8	4.82	13/16	20.64	9/16	14.28	15.24	17.78	24.38	31.75	22.35
SLF-4-8N	1/4	6.35	1/2	4.82	1	25.40	9/16	14.28	15.24	17.78	27.17	34.54	28.44
SLF-5-2N	5/16	7.93	1/8	6.35	9/16	14.28	5/8	15.87	16.25	18.54	21.33	28.70	19.05
SLF-5-4N	5/16	7.93	1/4	6.35	11/16	17.46	5/8	15.87	16.25	18.54	23.11	30.48	22.35
SLF-6-2N	3/8	9.52	1/8	7.11	5/8	15.87	11/16	17.46	16.76	19.30	23.11	30.48	19.05
SLF-6-4N	3/8	9.52	1/4	7.11	11/16	17.46	11/16	17.46	16.76	19.30	23.87	31.24	22.35
SLF-6-6N	3/8	9.52	3/8	7.11	13/16	20.64	11/16	17.46	16.76	19.30	25.90	33.27	22.35
SLF-6-8N	3/8	9.52	1/2	7.11	1	25.40	11/16	17.46	16.76	19.30	28.70	36.06	28.44
SLF-8-4N	1/2	12.70	1/4	10.41	13/16	20.64	7/8	22.22	22.86	21.84	25.90	36.06	22.35
SLF-8-6N	1/2	12.70	3/8	10.41	13/16	20.64	7/8	22.22	22.86	21.84	25.90	36.06	22.35
SLF-8-8N	1/2	12.70	1/2	10.41	1	25.40	7/8	22.22	22.86	21.84	28.70	38.86	28.44
SLF-10-6N	5/8	15.87	3/8	12.70	15/16	23.81	1	25.40	24.38	21.84	27.94	38.10	22.35
SLF-10-8N	5/8	15.87	1/2	12.70	1	25.40	1	25.40	24.38	21.84	29.71	39.87	28.44
SLF-12-8N	3/4	19.05	1/2	15.74	1-1/16	26.98	1-1/8	28.58	24.38	21.84	29.71	39.87	28.44
SLF-12-12N	3/4	19.05	3/4	15.74	1-1/4	31.75	1-1/8	28.58	24.38	21.84	34.54	44.70	31.75
SLF-14-12N	7/8	22.22	3/4	18.28	1-1/4	31.75	1-1/4	31.75	25.90	21.84	34.54	44.70	31.75
SLF-16-12N	1	25.40	3/4	22.35	1-27/64	36.00	1-1/2	38.10	31.24	26.41	36.83	49.02	31.75
SLF-16-16N	1	25.40	1	22.35	1-11/16	42.86	1-1/2	38.10	31.24	26.41	41.40	50.29	38.10

Connects metric tube to male NPT thread

Part No.	Tube O.D. D	T (NPT)	E Min.	Width across flat		A	B	l	L	L <sub>1</sub>
				h	H					
SLF-6M-2N	6	1/8	4.8	12.70	14	15.3	17.7	19.6	27.0	19.00
SLF-6M-4N	6	1/4	4.8	17.46	14	15.3	17.7	22.4	29.8	22.40
SLF-6M-6N	6	3/8	4.8	20.64	14	15.3	17.7	24.4	31.7	22.40
SLF-6M-8N	6	1/2	4.8	25.40	14	15.3	17.7	27.2	34.6	28.40
SLF-8M-2N	8	1/8	6.4	15.87	16	16.2	18.6	23.1	29.9	19.00
SLF-8M-4N	8	1/4	6.4	17.46	16	16.2	18.6	23.1	30.6	22.40
SLF-8M-8N	8	1/2	6.4	25.40	16	16.2	18.6	28.0	35.2	28.40
SLF-10M-2N	10	1/8	7.9	17.46	19	17.2	19.5	23.9	31.5	19.00
SLF-10M-4N	10	1/4	7.9	20.64	19	17.2	19.5	25.9	33.5	22.40
SLF-10M-6N	10	3/8	7.9	20.64	19	17.2	19.5	25.9	33.5	22.40
SLF-10M-8N	10	1/2	7.9	25.40	19	17.2	19.5	28.7	36.1	28.40
SLF-12M-4N	12	1/4	9.5	20.64	22	22.8	22.0	25.9	36.0	22.40
SLF-12M-6N	12	3/8	9.5	20.64	22	22.8	22.0	25.9	36.2	22.35
SLF-12M-8N	12	1/2	9.5	25.40	22	22.8	22.0	28.7	38.8	28.40
SLF-16M-8N	16	1/2	12.7	26.98	25	24.4	22.0	29.7	39.5	28.40

## Female Run Tee STRF

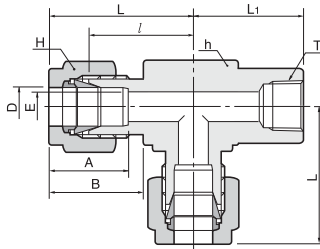

Connects fractional tube to male NPT thread

Part No.	Tube O D		T (NPT)	E Min.	Width across flat				A	B	l	L	L <sub>1</sub>
	D				h	H	A	B					
	in	mm											
STRF-2-2N	1/8	3.17	1/8	2.28	1/2	12.70	7/16	11.11	12.70	15.24	18.03	24.63	19.05
STRF-2-4N	1/8	3.17	1/4	2.28	11/16	17.46	7/16	11.11	12.70	15.24	20.82	27.43	22.35
STRF-3-2N	3/16	4.76	1/8	3.04	1/2	12.70	1/2	12.70	13.71	16.00	18.79	25.40	19.05
STRF-4-2N	1/4	6.35	1/8	4.82	1/2	12.70	9/16	14.28	15.24	17.78	19.55	26.92	19.05
STRF-4-4N	1/4	6.35	1/4	4.82	11/16	17.46	9/16	14.28	15.24	17.78	22.86	29.71	22.35
STRF-4-6N	1/4	6.35	3/8	4.82	13/16	20.64	9/16	14.28	15.24	17.78	24.38	31.75	22.35
STRF-4-8N	1/4	6.35	1/2	4.82	1	25.40	9/16	14.28	15.24	17.78	27.17	34.54	28.44
STRF-5-2N	5/16	7.94	1/8	6.35	9/16	14.28	5/8	15.87	16.25	18.54	21.33	28.70	19.05
STRF-5-4N	5/16	7.94	1/4	6.35	11/16	17.46	5/8	15.87	16.25	18.54	23.11	30.48	22.35
STRF-6-2N	3/8	9.52	1/8	7.11	5/8	15.87	11/16	17.46	16.76	19.30	23.11	30.48	19.05
STRF-6-4N	3/8	9.52	1/4	7.11	11/16	17.46	11/16	17.46	16.76	19.30	23.87	31.24	22.35
STRF-6-6N	3/8	9.52	3/8	6.35	13/16	20.64	11/16	17.46	16.76	19.30	25.90	33.27	22.35
STRF-6-8N	3/8	9.52	1/2	7.11	1	25.40	11/16	17.46	16.76	19.30	28.70	36.06	28.44
STRF-8-4N	1/2	12.70	1/4	10.41	13/16	20.64	7/8	22.22	22.86	21.84	25.90	36.06	22.35
STRF-8-6N	1/2	12.70	3/8	10.41	13/16	20.64	7/8	22.22	22.86	21.84	25.90	36.06	22.35
STRF-8-8N	1/2	12.70	1/2	10.41	1	25.40	7/8	22.22	22.86	21.84	29.71	39.87	28.44
STRF-10-6N	5/8	15.87	3/8	12.70	15/16	23.81	1	25.40	24.38	21.84	27.94	38.10	22.35
STRF-10-8N	5/8	15.87	1/2	12.70	1	25.40	1	25.40	24.38	21.84	28.70	38.86	28.44
STRF-12-8N	3/4	19.05	1/2	15.74	1-1/16	26.98	1-1/8	28.58	24.38	21.84	29.71	39.87	28.44
STRF-12-12N	3/4	19.05	3/4	15.74	1-1/4	31.75	1-1/8	28.58	24.38	21.84	34.54	44.70	31.75
STRF-14-12N	7/8	22.22	3/4	18.28	1-1/4	31.75	1-1/4	31.75	31.75	21.84	34.54	44.70	31.75
STRF-16-12N	1	25.40	3/4	22.35	1-27/64	36.12	1-1/2	38.10	38.10	26.41	36.83	49.02	31.75
STRF-16-16N	1	25.40	1	22.35	1-1/16	42.86	1-1/2	38.10	38.10	26.41	41.40	50.29	38.10

Connects metric tube to male NPT thread

Part No.	Tube O.D.		T (NPT)	E Min.	Width across flat		A	B	l	L	L <sub>1</sub>
	D				h	H					
	in	mm									
STRF-6M-2N	6	1/8	4.8	4.8	12.70	14	15.3	17.7	19.6	27.0	19.00
STRF-6M-4N	6	1/4	4.8	4.8	17.46	14	15.3	17.7	22.4	29.8	22.40
STRF-6M-6N	6	3/8	4.8	4.8	20.64	14	15.3	17.7	24.4	31.7	22.40
STRF-6M-8N	6	1/2	4.8	4.8	25.40	14	15.3	17.7	27.2	34.5	28.40
STRF-8M-2N	8	1/8	6.4	6.4	15.87	16	16.2	18.6	23.1	29.9	19.00
STRF-8M-4N	8	1/4	6.4	6.4	17.46	16	16.2	18.6	23.1	30.6	22.40
STRF-8M-6N	8	3/8	6.4	6.4	20.64	16	16.2	18.6	25.2	32.4	22.40
STRF-8M-8N	8	1/2	6.4	6.4	25.40	16	16.2	18.6	28.0	35.2	28.40
STRF-10M-2N	10	1/8	7.9	7.9	20.64	19	17.2	19.5	23.9	31.5	19.00
STRF-10M-4N	10	1/4	7.9	7.9	20.64	19	17.2	19.5	25.9	33.6	22.40
STRF-10M-6N	10	3/8	7.9	7.9	20.64	19	17.2	19.5	25.9	33.6	22.40
STRF-10M-8N	10	1/2	7.9	7.9	25.40	19	17.2	19.5	26.2	33.6	28.40
STRF-12M-4N	12	1/4	9.5	9.5	20.64	22	22.8	22.0	25.9	36.0	22.40
STRF-12M-6N	12	3/8	9.5	9.5	20.64	22	22.8	22.0	25.9	36.0	22.40
STRF-12M-8N	12	1/2	9.5	9.5	25.40	22	22.8	22.0	29.7	40.0	28.40
STRF-16M-8N	16	1/2	12.7	12.7	25.40	25	24.4	22.0	29.7	40.0	28.40

Female Branch Tee  
**STBF**

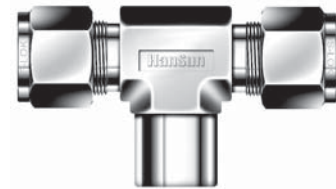
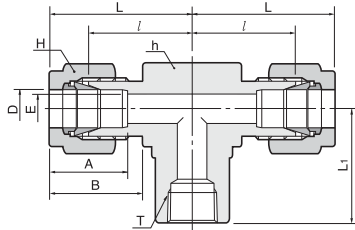

Connects fractional tube to male NPT thread

Part No.	Tube O.D. D		T (NPT)	E Min.	Width across flat				A	B	l	L	L <sub>1</sub>
	in	mm			h	H	in	mm					
STBF-2-2N	1/8	3.17	1/8	2.28	1/2	12.70	7/16	11.11	12.70	15.24	18.03	24.38	19.05
STBF-2-4N	1/8	3.17	1/4	2.28	11/16	17.46	7/16	11.11	12.70	15.24	20.82	27.43	22.35
STBF-3-2N	3/16	4.76	1/8	3.04	1/2	12.70	1/2	12.70	13.71	16.00	18.79	25.40	19.05
STBF-4-2N	1/4	6.35	1/8	4.82	1/2	12.70	9/16	14.28	15.24	17.78	19.55	26.92	19.05
STBF-4-4N	1/4	6.35	1/4	4.82	11/16	17.46	9/16	14.28	15.24	17.78	22.35	29.71	22.35
STBF-4-6N	1/4	6.35	3/8	4.82	13/16	20.64	9/16	14.28	15.24	17.78	24.38	31.75	22.35
STBF-4-8N	1/4	6.35	1/2	4.82	1	25.40	9/16	14.28	15.24	17.78	27.17	34.54	28.44
STBF-5-2N	5/16	7.94	1/8	6.35	9/16	14.28	5/8	15.87	16.25	18.54	21.33	28.70	19.05
STBF-5-4N	5/16	7.94	1/4	6.35	11/16	17.46	5/8	15.87	16.25	18.54	23.11	30.48	22.35
STBF-6-2N	3/8	9.52	1/8	7.11	5/8	15.87	11/16	17.46	16.76	19.30	23.11	30.48	19.05
STBF-6-4N	3/8	9.52	1/4	7.11	11/16	17.46	11/16	17.46	16.76	19.30	23.87	31.24	22.35
STBF-6-6N	3/8	9.52	3/8	6.35	13/16	20.64	11/16	17.46	16.76	19.30	25.90	33.27	22.35
STBF-6-8N	3/8	9.52	1/2	7.11	1	25.40	11/16	17.46	16.76	19.30	28.70	36.06	28.44
STBF-8-4N	1/2	12.70	1/4	10.41	13/16	20.64	7/8	22.22	22.86	21.84	25.90	36.06	22.35
STBF-8-6N	1/2	12.70	3/8	10.41	13/16	20.64	7/8	22.22	22.86	21.84	25.90	36.06	22.35
STBF-8-8N	1/2	12.70	1/2	10.41	1	25.40	7/8	22.22	22.86	21.84	29.71	39.87	28.44
STBF-10-6N	5/8	15.87	3/8	12.70	15/16	23.81	1	25.40	24.38	21.84	27.94	38.10	22.35
STBF-10-8N	5/8	15.87	1/2	12.70	1	25.40	1	25.40	24.38	21.84	28.70	38.86	28.44
STBF-12-8N	3/4	19.05	1/2	15.74	1-1/16	26.98	1-1/8	28.58	24.38	21.84	29.71	39.87	28.44
STBF-12-12N	3/4	19.05	3/4	15.74	1-1/4	31.75	1-1/8	28.58	24.38	21.84	34.54	44.70	31.75
STBF-14-12N	7/8	22.22	3/4	18.28	1-1/4	31.75	1-1/4	31.75	25.90	21.84	34.54	44.70	31.75
STBF-16-12N	1	25.40	3/4	22.35	1-27/64	36.00	1-1/2	38.10	31.24	26.41	36.83	49.02	31.75
STBF-16-16N	1	25.40	1	22.35	1-11/16	42.86	1-1/2	38.10	31.24	26.41	41.40	53.59	38.10

Connects metric tube to male NPT thread

Part No.	Tube O.D. D		T (NTP)	E Min.	Width across flat		A	B	l	L	L <sub>1</sub>
	mm	mm			h	H					
STBF-6M-2N	6	6	1/8	4.8	12.70	14	15.3	17.7	19.6	27.0	19.00
STBF-6M-4N	6	6	1/4	4.8	17.46	14	15.3	17.7	22.4	29.8	22.40
STBF-6M-6N	6	6	3/8	4.8	20.64	14	15.3	17.7	24.4	31.7	22.40
STBF-6M-8N	6	6	1/2	4.8	25.40	14	15.3	17.7	27.2	34.5	28.40
STBF-8M-2N	8	8	1/8	6.4	15.87	16	16.2	18.6	23.1	29.9	19.00
STBF-8M-4N	8	8	1/4	6.4	17.46	16	16.2	18.6	23.1	30.6	22.40
STBF-8M-6N	8	8	3/8	6.4	20.64	16	16.2	18.6	25.2	32.4	22.40
STBF-8M-8N	8	8	1/2	6.4	25.40	16	16.2	18.6	28.0	35.2	28.40
STBF-10M-2N	10	10	1/8	7.9	17.50	19	17.2	19.5	23.9	31.5	19.00
STBF-10M-4N	10	10	1/4	7.9	20.64	19	17.2	19.5	25.9	33.5	22.40
STBF-10M-6N	10	10	3/8	7.9	20.64	19	17.2	19.5	25.9	33.5	22.40
STBF-10M-8N	10	10	1/2	9.5	25.40	19	17.2	19.5	26.2	33.6	22.40
STBF-12M-4N	12	12	1/4	9.5	20.64	22	22.8	22.0	25.9	36.0	22.40
STBF-12M-6N	12	12	3/8	9.5	20.64	22	22.8	22.0	25.9	36.0	22.40
STBF-12M-8N	12	12	1/2	9.5	25.40	22	22.8	22.0	29.7	40.0	28.40
STBF-16M-8N	16	16	1/2	12.7	25.40	25	24.4	22.0	29.7	40.0	28.70

# S-LOK Tube Fittings

## Reducer SR

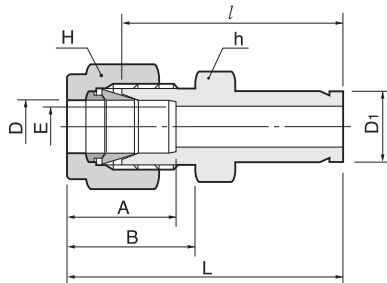

Connects fractional tube to fractional S-LOK port

Part No.	Tube O.D.				E Min.	Width across flat				A	B	l	L
	D		D1			h		H					
	in	mm	in	mm		in	mm	in	mm				
SR - 1-2	1/16	1.59	1/8	3.17	1.27	5/16	7.93	5/16	7.93	8.63	10.92	25.40	29.21
SR - 1-4	1/16	1.59	1/4	6.35	1.27	5/16	7.93	5/16	7.93	8.63	10.92	27.68	31.49
SR - 2-1	1/8	3.17	1/16	1.59	1.76	7/16	11.11	7/16	11.11	12.70	15.24	22.35	28.95
SR - 2-2	1/8	3.17	1/8	3.17	2.03	7/16	11.11	7/16	11.11	12.70	15.24	26.92	33.52
SR - 2-3	1/8	3.17	3/16	4.76	2.28	7/16	11.11	7/16	11.11	12.70	15.24	27.68	34.29
SR - 2-4	1/8	3.17	1/4	6.35	2.28	7/16	11.11	7/16	11.11	12.70	15.24	29.46	36.06
SR - 2-6	1/8	3.17	3/8	9.52	2.28	7/16	11.11	7/16	11.11	12.70	15.24	30.98	37.59
SR - 2-8	1/8	3.17	1/2	12.70	2.28	9/16	14.28	7/16	11.11	12.70	15.24	37.59	44.19
SR - 3-2	3/16	4.76	1/8	3.17	2.03	7/16	11.11	1/2	12.70	13.71	16.00	28.19	34.79
SR - 3-4	3/16	4.76	1/4	6.35	3.04	7/16	11.11	1/2	12.70	13.71	16.00	30.48	37.08
SR - 4-2	1/4	6.35	1/8	3.17	2.03	1/2	12.70	9/16	14.28	15.24	17.78	29.46	36.83
SR - 4-3	1/4	6.35	3/16	4.76	3.04	1/2	12.70	9/16	14.28	15.24	17.78	30.22	37.59
SR - 4-4	1/4	6.35	1/4	6.35	4.82	1/2	12.70	9/16	14.28	15.24	17.78	31.75	39.11
SR - 4-5	1/4	6.35	5/16	7.93	4.82	1/2	12.70	9/16	14.28	15.24	17.78	32.51	39.87
SR - 4-6	1/4	6.35	3/8	9.52	4.82	1/2	12.70	9/16	14.28	15.24	17.78	33.27	40.64
SR - 4-8	1/4	6.35	1/2	12.70	4.82	9/16	14.28	9/16	14.28	15.24	17.78	38.86	46.22
SR - 4-10	1/4	6.35	5/8	15.87	4.82	11/16	17.46	9/16	14.28	15.24	17.78	40.64	48.00
SR - 4-12	1/4	6.35	3/4	19.05	4.82	13/16	20.64	9/16	14.28	15.24	17.78	40.38	47.75
SR - 5-6	5/16	7.93	3/8	9.52	6.35	9/16	14.28	5/8	15.87	16.25	18.54	34.54	41.91
SR - 5-8	5/16	7.93	1/2	12.70	6.35	9/16	14.28	5/8	15.87	16.25	18.54	40.13	47.49
SR - 6-4	3/8	9.52	1/4	6.35	4.82	5/8	15.87	11/16	17.46	16.76	19.30	34.03	41.40
SR - 6-6	3/8	9.52	3/8	9.52	7.11	5/8	15.87	11/16	17.46	16.76	19.30	35.81	43.18
SR - 6-8	3/8	9.52	1/2	12.70	7.11	5/8	15.87	11/16	17.46	16.76	19.30	41.14	48.51
SR - 6-10	3/8	9.52	5/8	15.87	7.11	11/16	17.46	11/16	17.46	16.76	19.30	42.92	50.29
SR - 6-12	3/8	9.52	3/4	19.05	7.11	13/16	20.64	11/16	17.46	16.76	19.30	42.92	50.29
SR - 8-4	1/2	12.70	1/4	6.35	4.82	13/16	20.64	7/8	22.22	22.86	21.84	34.79	44.95
SR - 8-6	1/2	12.70	3/8	9.52	7.11	13/16	20.64	7/8	22.22	22.86	21.84	36.57	46.73
SR - 8-8	1/2	12.70	1/2	12.70	9.90	13/16	20.64	7/8	22.22	22.86	21.84	42.16	52.32
SR - 8-10	1/2	12.70	5/8	15.87	10.41	13/16	20.64	7/8	22.22	22.86	21.84	43.68	53.84
SR - 8-12	1/2	12.70	3/4	19.05	10.41	13/16	20.64	7/8	22.22	22.86	21.84	43.68	53.84
SR - 8-16	1/2	12.70	1	25.40	10.41	1-1/16	26.98	7/8	22.22	22.86	21.84	50.03	60.19
SR - 10-12	5/8	15.87	3/4	19.05	12.70	15/16	23.81	1	25.40	24.38	21.84	44.45	54.61
SR - 10-14	5/8	15.87	7/8	22.22	12.70	15/16	23.81	1	25.40	24.38	21.84	45.97	56.13
SR - 10-16	5/8	15.87	1	25.40	12.70	1-1/16	26.98	1	25.40	24.38	21.84	50.80	60.96
SR - 12-8	3/4	19.05	1/2	12.70	9.90	1-1/16	26.98	1-1/8	28.57	24.38	21.84	44.45	54.61
SR - 12-16	3/4	19.05	1	25.40	15.74	1-1/16	26.98	1-1/8	28.57	24.38	21.84	52.32	62.48
SR - 16-20	1	25.40	1-1/4	31.75	22.35	1-3/8	34.93	1-1/2	38.10	31.24	26.41	68.32	80.51
SR - 16-24	1	25.40	1-1/2	38.10	22.35	1-5/8	41.28	1-1/2	38.10	31.24	26.41	76.96	89.15
SR - 16-32	1	25.40	2	50.80	22.35	2-1/8	53.98	1-1/2	38.10	31.24	26.41	100.33	112.52
SR - 20-24	1-1/4	31.75	1-1/2	38.10	27.68	1-7/8	47.63	2-1/4	57.15	41.14	38.86	82.04	104.14
SR - 20-32	1-1/4	31.75	2	50.80	27.68	1-7/8	47.63	3	76.20	41.14	38.86	103.12	125.22
SR - 24-32	1-1/2	38.10	2	50.80	34.03	2-1/4	57.15	3	76.20	50.03	45.21	104.14	131.31



Reducer  
**SR**

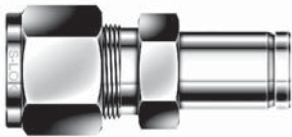
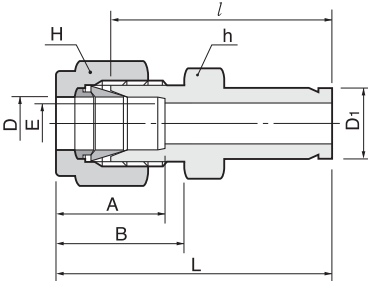

Connects metric tube to fractional S-LOK port

Part No.	Tube O.D.		E Min.	Width across flat		A	B	l	L	
	D	D1		h	H					
SR - 2M-2	2	1/8	3.17	1.7	12	12	12.9	15.3	26.9	33.5
SR - 3M-2	3	1/8	3.17	2.0	12	12	12.9	15.3	26.9	33.5
SR - 3M-4	3	1/4	6.35	2.4	12	12	12.9	15.3	29.5	36.1
SR - 4M-4	4	1/4	6.35	2.4	12	12	13.7	16.1	30.5	37.1
SR - 6M-2	6	1/8	3.18	2.0	14	14	15.3	17.7	29.5	36.9
SR - 6M-4	6	1/4	6.35	4.8	14	14	15.3	17.7	31.8	39.2
SR - 6M-5	6	5/16	7.93	4.8	14	14	15.3	17.7	32.5	39.9
SR - 6M-6	6	3/8	9.52	4.8	14	14	15.3	17.7	33.3	40.7
SR - 6M-8	6	1/2	12.70	4.8	14	14	15.3	17.7	38.9	46.3
SR - 8M-6	8	3/8	9.52	6.4	15	16	16.2	18.6	34.5	42.0
SR - 8M-8	8	1/2	12.70	6.4	15	16	16.2	18.6	40.1	47.6
SR - 10M-6	10	3/8	9.52	7.1	18	19	17.2	19.5	36.6	44.2
SR - 10M-8	10	1/2	12.70	7.9	18	19	17.2	19.5	42.2	49.8
SR - 12M-8	12	1/2	12.70	9.5	22	22	22.8	22.0	42.2	52.3
SR - 12M-12	12	3/4	19.05	9.5	22	22	22.8	22.0	43.7	53.8
SR - 18M-12	18	3/4	19.05	15.1	27	30	24.4	22.0	46.0	56.1
SR - 18M-16	18	1	25.40	15.1	27	30	24.4	22.0	52.3	62.4
SR - 25M-16	25	1	25.40	20.2	35	38	31.3	26.5	57.2	69.5

Connects metric tube to metric S-LOK port

Part No.	Tube O.D.		E Min.	Width across flat		A	B	l	L
	D	D1		h	H				
SR - 2M-3M	2	3	1.7	12	12	12.9	15.3	26.9	35.3
SR - 3M-4M	3	4	2.4	12	12	12.9	15.3	28.4	35.0
SR - 3M-6M	3	6	2.4	12	12	12.9	15.3	29.5	36.1
SR - 3M-10M	3	10	2.4	12	12	12.9	15.3	31.8	38.4
SR - 4M-6M	4	6	2.4	12	12	13.7	16.1	30.5	37.1
SR - 6M-3M	6	3	1.8	14	14	15.3	17.7	29.5	36.9
SR - 6M-8M	6	8	4.8	14	14	15.3	17.7	32.5	39.9
SR - 6M-10M	6	10	4.8	14	14	15.3	17.7	33.3	40.7
SR - 6M-12M	6	12	4.8	14	14	15.3	17.7	38.9	46.3
SR - 8M-6M	8	6	4.6	15	16	16.2	18.6	32.8	40.3
SR - 8M-10M	8	10	6.4	15	16	16.2	18.6	34.5	42.0
SR - 8M-12M	8	12	6.4	15	16	16.2	18.6	40.1	47.6
SR - 10M-6M	10	6	4.6	18	19	17.2	19.5	34.8	42.4
SR - 10M-12M	10	12	7.9	18	19	17.2	19.5	42.2	49.8
SR - 10M-15M	10	15	7.9	18	19	17.2	19.5	43.7	51.3
SR - 10M-18M	10	18	7.9	19	19	17.2	19.5	43.7	51.3
SR - 12M-6M	12	6	4.6	22	22	22.8	22.0	34.8	44.9
SR - 12M-10M	12	10	7.7	22	22	22.8	22.0	36.6	46.7
SR - 12M-16M	12	16	9.5	22	22	22.8	22.0	43.7	53.8
SR - 12M-18M	12	18	9.5	22	22	22.8	22.0	43.7	53.8
SR - 12M-20M	12	20	9.5	22	22	22.8	22.0	46.0	56.1
SR - 12M-22M	12	22	9.5	24	22	22.8	22.0	46.0	56.1
SR - 12M-25M	12	25	9.5	27	22	22.8	22.0	52.3	62.4
SR - 16M-12M	16	12	9.1	24	25	24.4	22.0	42.9	53.0
SR - 18M-12M	18	12	9.1	27	30	24.4	22.0	44.5	54.6
SR - 18M-16M	18	16	12.7	27	30	24.4	22.0	46.0	56.1
SR - 18M-20M	18	20	15.1	27	30	24.4	22.0	47.5	57.6
SR - 18M-22M	18	22	15.1	27	30	24.4	22.0	47.5	57.6
SR - 18M-25M	18	25	15.1	27	30	24.4	22.0	52.3	62.4
SR - 20M-16M	20	16	12.7	30	32	26.0	22.0	47.8	57.9
SR - 20M-18M	20	18	13.9	30	32	26.0	22.0	47.8	57.9
SR - 20M-22M	20	22	15.8	30	32	26.0	22.0	49.3	59.4
SR - 20M-25M	20	25	15.8	30	32	26.0	22.0	54.1	64.2
SR - 22M-18M	22	18	13.9	30	32	26.0	22.0	47.8	57.9
SR - 22M-20M	22	20	15.1	30	32	26.0	22.0	49.3	59.4
SR - 22M-25M	22	25	18.3	30	32	26.0	22.0	54.1	64.2
SR - 25M-18M	25	18	13.9	35	38	31.3	26.5	50.8	63.1
SR - 25M-20M	25	20	15.1	35	38	31.3	26.5	52.3	64.6

## Bulkhead Adapter SAB

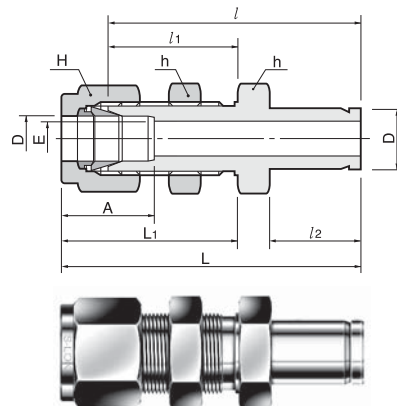
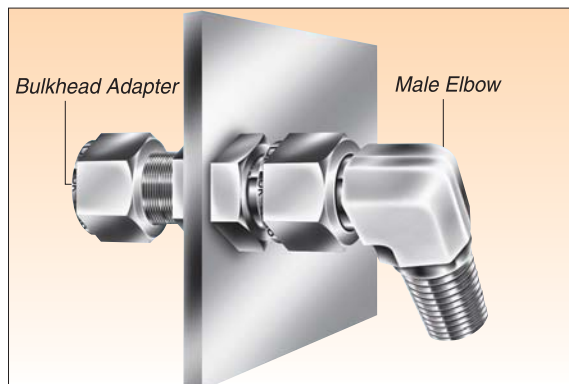

The bulkhead adapter is useful for panel construction when you need to set a direction.

Set a direction

Connects fractional tube to fractional S-LOK port

Part No.	Tube O.D. D		E Min.	Width across flat				A	l	l <sub>1</sub>	l <sub>2</sub>	L	L <sub>1</sub>	Panel Hole Drill Size	Panel Max Thickness
	in	mm		h	mm	in	H								
SAB - 2-2	1/8	3.17	2.03	1/2	12.70	7/16	11.11	12.70	42.92	24.63	13.45	49.53	31.24	8.33	12.70
SAB - 4-4	1/4	6.35	4.82	5/8	15.87	9/16	14.28	15.24	48.51	26.16	15.74	55.88	33.52	11.50	10.16
SAB - 6-6	3/8	9.52	7.11	3/4	19.05	11/16	17.46	16.76	53.84	29.46	17.50	61.21	36.83	14.68	11.17
SAB - 8-8	1/2	12.70	10.41	15/16	23.81	7/8	22.22	22.86	62.73	31.75	23.11	72.89	41.91	19.44	12.70
SAB - 10-10	5/8	15.87	12.70	1-1/16	26.98	1	25.40	24.38	65.02	32.51	24.70	75.18	42.67	22.62	12.70
SAB - 16-16	1	25.40	20.32	1-5/8	41.28	1-1/2	38.10	31.24	88.13	45.21	31.70	100.33	57.40	33.73	19.05
SAB - 20-20	1-1/4	31.75	27.68	1-7/8	47.63	1-7/8	47.63	41.14	102.07	47.75	40.00	124.17	69.85	41.67	19.05
SAB - 24-24	1-1/2	38.10	34.03	2-1/4	57.15	2-1/4	57.15	50.03	118.33	49.27	51.50	145.51	76.45	49.61	19.05
SAB - 32-32	2	50.80	45.97	2-3/4	69.85	3	76.20	67.56	148.79	56.38	68.40	185.82	93.71	57.94	19.05

## Male Adapter SAM

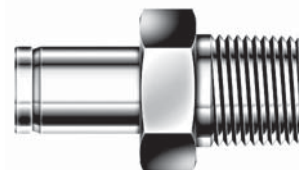
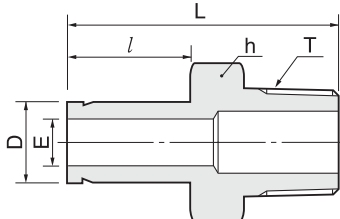

Connects metric S-LOK port to female ISO tapered thread

Part No.	Tube O.D. D		T R(PT)	E Min.	Width across flat		l	L
	in	mm			h	mm		
SAM-3M-2R	3		1/8	1.9	12		13.15	29.4
SAM-6M-2R	6		1/8	4.1	12		15.75	32.8
SAM-6M-4R	6		1/4	4.1	14		15.75	38.1
SAM-8M-4R	8		1/4	5.6	14		16.50	39.1
SAM-10M-4R	10		1/4	7.1	14		17.50	39.9
SAM-10M-6R	10		3/8	7.1	17		17.50	40.6
SAM-10M-8R	10		1/2	7.1	22		17.50	46.2
SAM-12M-4R	12		1/4	8.8	14		23.50	46.5
SAM-12M-6R	12		3/8	8.8	17		23.50	46.5
SAM-12M-8R	12		1/2	8.8	22		23.50	51.8
SAM-18M-8R	18		1/2	13.9	22		24.90	53.2
SAM-18M-12R	18		3/4	13.9	27		24.90	53.2
SAM-28M-16R	28		1	22.5	35		31.70	74.7
SAM-28M-20R	28		1-1/4	22.5	46		31.70	76.2
SAM-32M-20R	32		1-1/4	26.5	46		40.00	81.0
SAM-38M-24R	38		1-1/2	31.6	55		51.50	92.2

## Male Adapter SAM

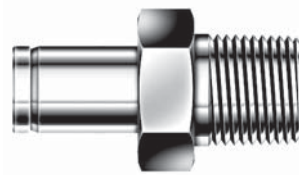
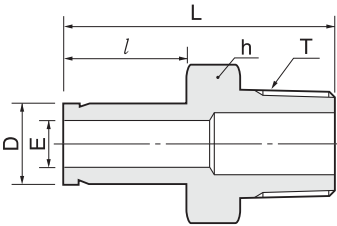

*S-LOK Adapter eliminates alignment problems*

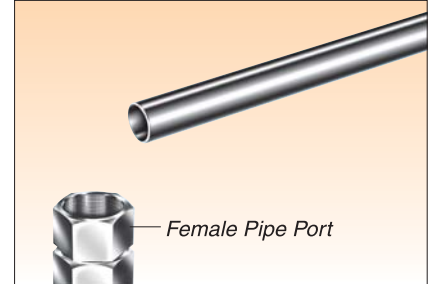

In the direction shown the female port is required to connect with tubing.

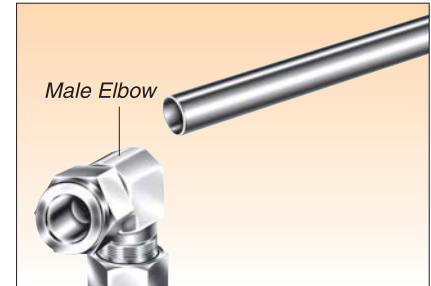

The male elbow is positioning in the wrong direction.

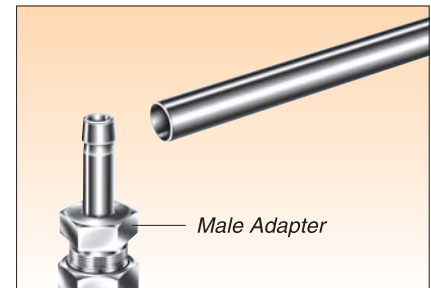

To eliminate the problem, use a male adapter into the female port.

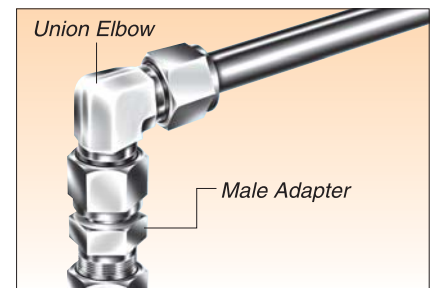

Connect a union elbow to the adapter by tightening the S-LOK port with a wrench while holding the elbow wrench pad in the desired direction

*Connects fractional S-LOK port to female NPT thread*

Part No.	Tube O.D.		T (NPT)	E Min.	Width across flat		l	L
	in	mm			h	h		
SAM - 2-2N	1/8	3.17	1/8	2.03	7/16	11.11	13.45	29.50
SAM - 2-4N	1/8	3.17	1/4	2.03	9/16	14.28	13.45	34.80
SAM - 3-2N	3/16	4.76	1/8	3.04	7/16	11.11	14.20	30.22
SAM - 3-4N	3/16	4.76	1/4	3.04	9/16	14.28	14.20	35.56
SAM - 4-2N	1/4	6.35	1/8	4.31	7/16	11.11	15.75	31.80
SAM - 4-4N	1/4	6.35	1/4	4.31	9/16	14.28	15.75	37.08
SAM - 4-6N	1/4	6.35	3/8	4.31	11/16	17.46	15.75	37.84
SAM - 4-8N	1/4	6.35	1/2	4.31	7/8	22.22	15.75	43.43
SAM - 5-2N	5/16	7.93	1/8	5.58	7/16	11.11	16.80	32.76
SAM - 5-4N	5/16	7.93	1/4	5.58	9/16	14.28	16.80	38.10
SAM - 6-2N	3/8	9.52	1/8	6.86	7/16	11.11	17.50	33.50
SAM - 6-4N	3/8	9.52	1/4	6.86	9/16	14.28	17.50	38.90
SAM - 6-6N	3/8	9.52	3/8	6.86	11/16	17.46	17.50	39.60
SAM - 6-8N	3/8	9.52	1/2	6.86	7/8	22.22	17.50	45.20
SAM - 8-4N	1/2	12.70	1/4	9.40	9/16	14.28	23.20	44.50
SAM - 8-6N	1/2	12.70	3/8	9.40	11/16	17.46	23.20	45.20
SAM - 8-8N	1/2	12.70	1/2	9.40	7/8	22.22	23.20	50.50
SAM - 10-6N	5/8	15.87	3/8	11.90	11/16	17.46	24.70	47.40
SAM - 10-8N	5/8	15.87	1/2	11.90	7/8	22.22	24.70	52.30
SAM - 10-12N	5/8	15.87	3/4	11.90	1-1/16	26.98	24.70	52.30
SAM - 12-8N	3/4	19.05	1/2	14.73	7/8	22.22	24.70	52.30
SAM - 12-12N	3/4	19.05	3/4	14.73	1-1/16	26.98	24.70	52.30
SAM - 12-16N	3/4	19.05	1	14.73	1-3/8	34.92	24.70	57.91
SAM - 14-12N	7/8	22.22	3/4	17.27	1-1/16	26.98	26.70	54.30
SAM - 16-12N	1	25.40	3/4	20.32	1-1/16	26.98	31.70	58.70
SAM - 16-16N	1	25.40	1	20.32	1-3/8	34.92	31.70	66.00
SAM - 20-20N	1-1/4	31.75	1-1/4	25.90	1-3/4	44.45	40.00	80.26
SAM - 24-24N	1-1/2	38.10	1-1/2	31.75	2-1/8	53.98	51.50	94.48
SAM - 32-32N	2	50.80	2	43.68	2-3/4	69.85	68.40	119.38

# S-LOK Tube Fittings

## Female Adapter SAF

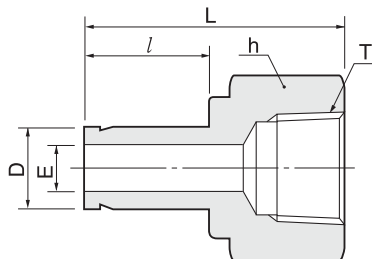

Connects fractional S-LOK port to male NPT thread

Part No.	Tube O.D. D		T (NPT)	E Min.	Width across flat h		l	L
	in	mm			in	mm		
SAF - 2-2N	1/8	3.17	1/8	2.03	9/16	14.28	13.45	31.50
SAF - 2-4N	1/8	3.17	1/4	2.03	3/4	19.05	13.45	35.30
SAF - 3-2N	3/16	4.76	1/8	3.04	9/16	14.28	14.20	32.00
SAF - 3-4N	3/16	4.76	1/4	3.04	3/4	19.05	14.20	35.81
SAF - 4-2N	1/4	6.35	1/8	4.31	9/16	14.28	15.75	33.02
SAF - 4-4N	1/4	6.35	1/4	4.31	3/4	19.05	15.75	37.10
SAF - 4-6N	1/4	6.35	3/8	4.31	7/8	22.22	15.75	39.37
SAF - 4-8N	1/4	6.35	1/2	4.31	1-1/16	26.98	15.75	45.50
SAF - 5-2N	5/16	7.93	1/8	5.58	9/16	14.28	16.80	34.29
SAF - 5-4N	5/16	7.93	1/4	5.58	3/4	19.05	16.80	37.59
SAF - 6-2N	3/8	9.52	1/8	6.86	9/16	14.28	17.50	34.29
SAF - 6-4N	3/8	9.52	1/4	6.86	3/4	19.05	17.50	38.10
SAF - 6-6N	3/8	9.52	3/8	6.86	7/8	22.22	17.50	40.38
SAF - 6-8N	3/8	9.52	1/2	6.86	1-1/16	26.98	17.50	46.73
SAF - 8-4N	1/2	12.70	1/4	9.4	3/4	19.05	23.20	43.43
SAF - 8-6N	1/2	12.70	3/8	9.4	7/8	22.22	23.20	45.46
SAF - 8-8N	1/2	12.70	1/2	9.4	1-1/16	26.98	23.20	51.80
SAF - 10-6N	5/8	15.87	3/8	11.9	7/8	22.22	24.70	48.26
SAF - 10-8N	5/8	15.87	1/2	11.9	1-1/16	26.98	24.70	53.84
SAF - 10-12N	5/8	15.87	3/4	11.9	1-5/16	33.33	24.70	55.37
SAF - 12-8N	3/4	19.05	1/2	14.73	1-1/16	26.98	24.70	52.83
SAF - 12-12N	3/4	19.05	3/4	14.73	1-5/16	33.33	24.70	54.86
SAF - 12-16N	3/4	19.05	1	14.73	1-5/8	41.27	24.70	58.42
SAF - 14-12N	7/8	22.22	3/4	17.27	1-5/16	33.33	26.70	57.15
SAF - 16-12N	1	25.40	3/4	20.32	1-5/16	33.33	31.70	60.70
SAF - 16-16N	1	25.40	1	20.32	1-5/8	41.27	31.70	64.26
SAF - 20-20N	1-1/4	31.75	1-1/4	25.9	2-1/8	53.98	40.00	77.72
SAF - 24-24N	1-1/2	38.10	1-1/2	31.75	2-3/8	60.33	51.50	88.90
SAF - 32-32N	2	50.80	2	43.68	2-7/8	73.03	68.40	107.44

Connects metric S-LOK port to male ISO tapered thread

Part No.	Tube O.D. D	T R(PT)	E Min.	Width across flat h	l	L
SAF - 3M-2R	3	1/8	1.9	14	13.15	31.15
SAF - 6M-2R	6	1/8	4.1	14	15.75	32.50
SAF - 6M-4R	6	1/4	4.1	19	15.75	37.10
SAF - 8M-4R	8	1/4	5.6	19	16.50	37.60
SAF - 10M-4R	10	1/4	7.1	19	17.50	38.10
SAF - 10M-6R	10	3/8	7.1	22	17.50	40.10
SAF - 10M-8R	10	1/2	7.1	27	17.50	46.50
SAF - 12M-4R	12	1/4	8.8	19	23.50	43.70
SAF - 12M-6R	12	3/8	8.8	22	23.50	46.00
SAF - 12M-8R	12	1/2	8.8	27	23.50	52.30
SAF - 18M-12R	18	3/4	13.9	32	24.90	54.80

Female Adapter  
**SAG**

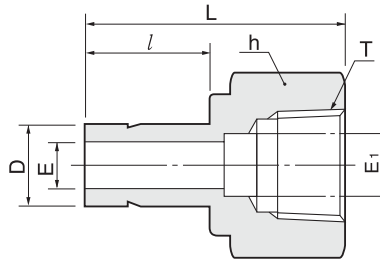

Connects fractional S-LOK port to male ISO tapered thread

Part No.	Tube O.D. D		T G(PF)	E Min.	E <sub>1</sub>	Width across flat h		l	l <sub>1</sub>	L
	in	mm				in	mm			
SAG-4-2G	1/4	6.35	1/8	4.3	4.57	9/16	14.28	15.75	12	32
SAG-4-4G	1/4	6.35	1/4	4.3	5.5	3/4	19.05	15.75	12.9	35.3
SAG-6-6G	3/8	9.52	3/8	6.6	6.5	15/16	23.81	17.5	14.1	39.37
SAG-8-8G	1/2	12.7	1/2	7.1	7	1-1/16	26.98	23.2	18.9	45.72

Connects metric S-LOK port to male ISO tapered thread

Part No.	Tube O.D. D		T G(PT)	E Min.	E <sub>1</sub>	Width across flat h		l	l <sub>1</sub>	L
	in	mm				in	mm			
SAG-6M-2G	6M	1/8	4.1	4	14	15.75	12	32		
SAG-6M-4G	6M	1/4	4.1	5.5	19	15.75	13	35.3		
SAG-6M-6G	6M	3/8	4.1	6.5	24	15.75	14.22	38.4		
SAG-6M-8G	6M	1/2	4.1	7	27	15.75	18.9	42.9		
SAG-8M-4G	8M	1/4	5.6	5.5	19	16.5	13	33		
SAG-8M-6G	8M	3/8	5.6	6.5	24	16.5	14.22	38.9		
SAG-8M-8G	8M	1/2	5.6	7	27	16.5	18.9	43.7		
SAG-10M-4G	10M	1/4	7.1	5.5	19	17.5	13	34.5		
SAG-10M-6G	10M	3/8	7.1	6.5	24	17.5	14.22	36.1		
SAG-10M-8G	10M	1/2	7.1	7	27	17.5	18.9	40.1		
SAG-12M-4G	12M	1/4	8.8	5.5	19	23.5	13	40.1		
SAG-12M-6G	12M	3/8	8.8	6.5	24	23.5	14.22	44.7		
SAG-12M-8G	12M	1/2	8.8	7	27	23.5	18.9	48.8		
SAG-15M-8G	15M	1/2	12.7	7	27	24.65	18.9	49		
SAG-16M-8G	16M	1/2	12.7	7	27	24.6	18.9	49		
SAG-18M-8G	18M	1/2	13.9	7	27	24.9	18.9	49.3		
SAG-22M-8G	22M	1/2	18.3	7	27	26.6	18.9	52		
SAG-25M-8G	25M	1/2	19.8	7	30	31.7	18.9	56.1		

# S-LOK Tube Fittings

## Port Connector SCP

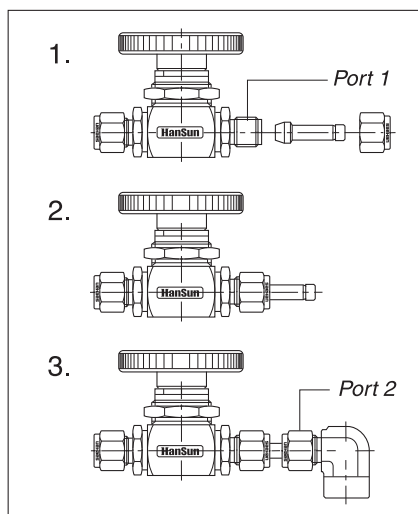
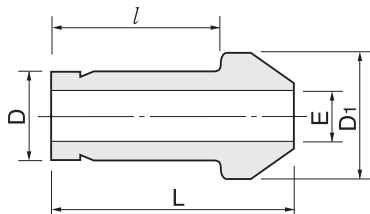

*S-LOK port connector facilitates close connection to another port.*

### Installation Instructions

1. Remove the nut and ferrules from S-LOK port 1 and set nut only (no ferrules) over the port connector
2. Tighten the nut with wrench until sharp rise in torque is felt
3. Insert the other end of port connector into port 2 and tighten nut 1-1/4 turns with wrench.  
for 1/8", 3mm only 3/4 turn from finger tight.

### Connects two fractional S-LOK ports

Part No.	Tube O.D.		E Min.	D <sub>1</sub>	l	L
	in	mm				
SCP-1	1/16	1.59	1.00	3.30	10.66	13.72
SCP-2	1/8	3.17	2.03	6.09	15.75	22.35
SCP-4	1/4	6.35	4.31	9.39	18.79	24.64
SCP-5	5/16	7.93	5.58	10.92	20.06	25.90
SCP-6	3/8	9.52	6.86	12.70	20.32	26.16
SCP-8	1/2	12.70	9.4	15.74	25.90	35.81
SCP-12	3/4	19.05	14.73	22.09	27.68	37.33
SCP-16	1	25.40	20.32	28.44	34.54	48.00

### Connects two metric S-LOK ports

Part No.	Tube O.D.		E Min.	D <sub>1</sub>	l	L
	D					
SCP-3M	3	1.9	6.0	15.70	22.20	
SCP-4M	4	2.2	7.0	16.67	25.81	
SCP-6M	6	4.1	9.0	18.70	24.60	
SCP-8M	8	5.6	11.0	20.00	25.90	
SCP-10M	10	7.1	13.1	20.20	26.10	
SCP-12M	12	8.8	15.0	26.00	35.80	
SCP-15M	15	11.2	19.0	27.78	37.40	
SCP-16M	16	12	19.0	27.60	37.40	
SCP-18M	18	13.9	21.0	27.91	37.40	
SCP-20M	20	15.5	23.0	29.20	38.90	
SCP-22M	22	17.9	24.97	29.30	39.20	
SCP-25M	25	19.9	28.0	34.50	48.00	
SCP-28M	28	22.5	34.3	48.30	63.50	
SCP-32M	32	26.5	39.5	52.40	69.70	
SCP-38M	38	31.6	47.1	61.40	81.90	

## Reducing Port Connector SCRP

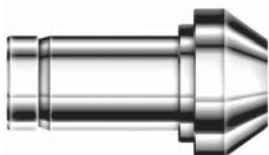
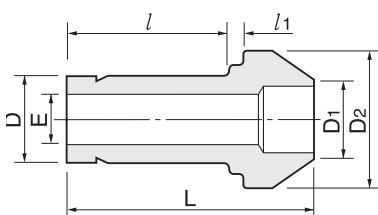

### Connects two fractional S-LOK ports

Part No.	Tube O.D.				E Min.	D <sub>2</sub>	l	l <sub>1</sub>	L
	D <sub>1</sub>		D						
	in	mm	in	mm					
SCRP 2-1	1/8	3.17	1/16	1.59	1.00	6.10	8.64	2.03	17.27
SCRP 4-2	1/4	6.35	1/8	3.17	2.28	9.39	13.45	3.30	22.60
SCRP 6-2	3/8	9.52	1/8	3.17	2.28	12.70	13.45	3.81	23.11
SCRP 6-4	3/8	9.52	1/4	6.35	4.82	12.70	15.75	3.30	24.89
SCRP 8-4	1/2	12.70	1/4	6.35	4.82	15.74	15.75	3.81	29.21
SCRP 8-6	1/2	12.70	3/8	9.52	7.11	15.74	17.50	3.30	30.48
SCRP 12-8	3/4	19.05	1/2	12.70	9.90	22.09	23.20	3.81	37.85
SCRP 16-8	1	25.40	1/2	12.70	9.90	28.40	24.47	4.82	42.67
SCRP 16-12	1	25.40	3/4	19.05	14.98	28.40	25.90	4.06	43.43

### Connects two metric S-LOK ports

Part No.	Tube O.D.		E Min.	D <sub>2</sub>	l	l <sub>1</sub>	L
	D <sub>1</sub>	D					
SCRP 6M-3M	6	3	1.9	9.0	13.50	3.2	22.60
SCRP 8M-6M	8	6	4.1	11.0	15.70	3.1	24.70
SCRP 10M-6M	10	6	4.1	13.1	15.70	3.4	25.00
SCRP 10M-8M	10	8	5.6	13.1	16.80	3.1	26.00
SCRP 12M-6M	12	6	4.1	15.0	15.70	3.6	29.10
SCRP 12M-8M	12	8	5.6	15.0	16.80	3.4	29.80
SCRP 12M-10M	12	10	7.1	15.0	17.50	3.1	30.40
SCRP 16M-6M	16	6	4.1	19.0	15.75	3.6	30.40
SCRP 16M-12M	16	12	8.8	19.0	23.10	3.4	36.20
SCRP 28M-25M	28	25	19.8	34.3	33.00	8.2	56.50
SCRP 32M-25M	32	25	19.8	39.5	33.00	9.9	60.30
SCRP 38M-25M	38	25	19.8	47.1	33.00	12.3	65.80

**AN Union  
SUA**

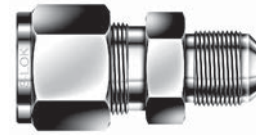
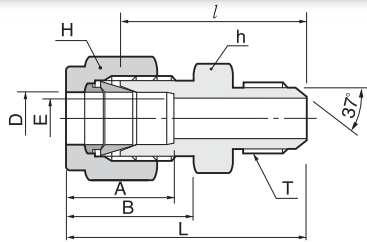

Connects fractional tube to AN flared tube

Part No.	Tube O.D. D		AN Tube Flare Size		Straight Thread T(U)	E Min.	Width across flat				A	B	l	L
	in	mm	in	mm			h		H					
SUA - 1-2	1/16	1.59	1/8	3.17	5/16-24	1.27	7/16	11.11	5/16	7.93	8.63	10.92	23.36	27.17
SUA - 2-2	1/8	3.17	1/8	3.17	5/16-24	1.52	7/16	11.11	7/16	11.11	12.70	15.24	24.89	31.49
SUA - 2-4	1/8	3.17	1/4	6.35	7/16-20	2.28	1/2	12.70	7/16	11.11	12.70	15.24	28.44	35.05
SUA - 4-4	1/4	6.35	1/4	6.35	7/16-20	4.31	1/2	12.70	9/16	14.28	15.24	17.78	30.22	37.59
SUA - 5-5	5/16	7.93	5/16	7.93	1/2-20	5.84	9/16	14.28	5/8	15.87	16.25	18.54	30.98	38.35
SUA - 6-4	3/8	9.52	1/4	6.35	7/16-20	4.31	5/8	15.87	11/16	17.46	16.76	19.30	32.25	39.62
SUA - 6-6	3/8	9.52	3/8	9.52	9/16-18	7.11	5/8	15.87	11/16	17.46	16.76	19.30	32.25	39.62
SUA - 8-8	1/2	12.70	1/2	12.70	3/4-16	9.90	13/16	20.64	7/8	22.22	22.86	21.84	35.81	45.97
SUA - 12-12	3/4	19.05	3/4	19.05	1-1/16-12	15.49	1-1/8	28.58	1-1/8	28.58	24.38	21.84	43.18	53.34
SUA - 16-16	1	25.40	1	25.40	1-5/16-12	21.33	1-3/8	34.92	1-1/2	38.10	31.24	26.41	49.27	61.46
SUA - 20-20	1-1/4	31.75	1-1/4	31.75	1-5/8-12	27.68	1-3/4	44.45	1-7/8	47.63	41.14	38.86	55.46	77.56
SUA - 24-24	1-1/2	38.10	1-1/2	38.10	1-7/8-12	34.03	2-1/8	53.97	2-1/4	57.15	50.03	45.21	63.07	90.25
SUA - 32-32	2	50.80	2	50.80	2-1/2-12	45.97	2-3/4	69.85	3	76.20	67.56	62.73	83.24	120.57

**AN Bulkhead Union  
SUBA**

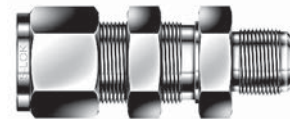
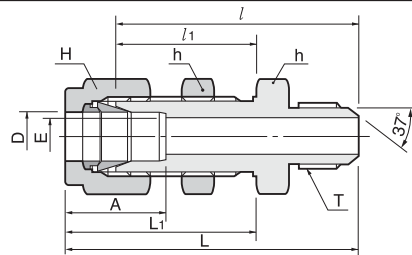

Connects fractional tube to AN flared tube

Part No.	Tube O.D. D		AN Tube Flare Size		Straight Thread T(U)	E Min.	Width across flat				A	l	l1	L	L1	Panel Hole Drill Size	Panel Max Thickness
	in	mm	in	mm			h		H								
SUBA - 2-2	1/8	3.17	1/8	3.17	5/16-24	1.77	1/2	12.70	7/16	11.11	13.71	40.85	24.63	47.45	31.23	8.33	12.70
SUBA - 4-4	1/4	6.35	1/4	6.35	7/16-20	4.31	5/8	15.87	9/16	14.28	15.24	46.48	26.16	53.84	33.52	11.50	10.16
SUBA - 6-6	3/8	9.52	3/8	9.52	9/16-18	7.11	3/4	19.05	11/16	17.46	16.76	49.78	29.46	57.15	36.83	14.68	11.17
SUBA - 8-8	1/2	12.70	1/2	12.70	3/4-16	9.90	5/16	23.81	7/8	22.22	22.86	55.62	31.75	65.78	41.91	19.44	12.70
SUBA - 12-12	3/4	19.05	3/4	19.05	1-1/16-12	15.49	1-3/16	30.16	1-1/8	28.58	24.38	68.83	37.33	78.99	47.49	25.79	16.76
SUBA - 16-16	1	25.40	1	25.40	1-5/16-12	21.33	1-5/8	41.27	1-1/2	38.10	31.24	80.26	45.21	92.45	57.40	33.73	19.05
SUBA - 20-20	1-1/4	31.75	1-1/4	31.75	1-5/8-12	27.68	1-7/8	47.63	1-7/8	47.63	41.14	86.37	47.75	108.47	69.85	41.67	19.05
SUBA - 24-24	1-1/2	38.10	1-1/2	38.10	1-7/8-12	34.03	2-1/4	57.15	2-1/4	57.15	50.03	94.33	49.27	121.51	76.45	49.61	19.05
SUBA - 32-32	2	50.80	2	50.80	2-1/2-12	45.97	2-3/4	69.85	3	76.20	67.56	114.29	56.38	151.62	93.71	16.27	19.05

**AN Adapter  
SAA**

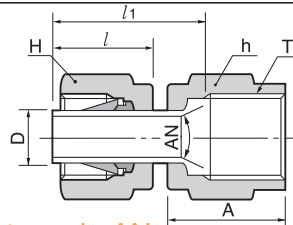

Connects fractional S-LOK port to male AN

Part No.	Tube O.D. D		AN Tube Flare Size		Straight Thread T(U)	Width across flat				A	l	l1
	in	mm	in	mm		h		H				
SAA-2-2	1/8	3.17	1/8	3.17	5/16-24	3/8	9.52	7/16	11.11	13.71	13.46	18.54
SAA-2-4	1/8	3.17	1/4	6.35	7/16-20	9/16	14.28	7/16	11.11	15.74	13.46	19.05
SAA-4-4	1/4	6.35	1/4	6.35	7/16-20	9/16	14.28	9/16	14.28	15.74	15.74	21.33
SAA-6-6	3/8	9.52	3/8	9.52	9/16-18	11/16	17.46	11/16	17.46	18.28	17.52	24.89
SAA-8-8	1/2	12.70	1/2	12.70	3/4-16	7/8	22.22	7/8	22.22	21.59	23.11	31.75

# S-LOK Tube Fittings

## SAE Fittings

S-LOK SAE straight O-Ring seal fittings are of positionable feature and provide connection tube to straight thread boss. Further this has an advantage of eliminating welding and brazing process when used as bulkhead fitting on thin wall tanks or vessels.

These fittings are designed and manufactured to SAE standards as below:

- Male or external fitting end dimensions to SAE J514
- Straight thread to SAE J475 (equivalent to ANSI B1.1 or ISO R725)
- Female or internal straight thread boss to SAE J1926. See diagram below.

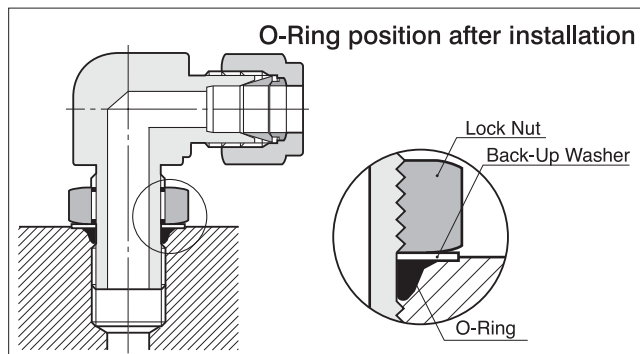
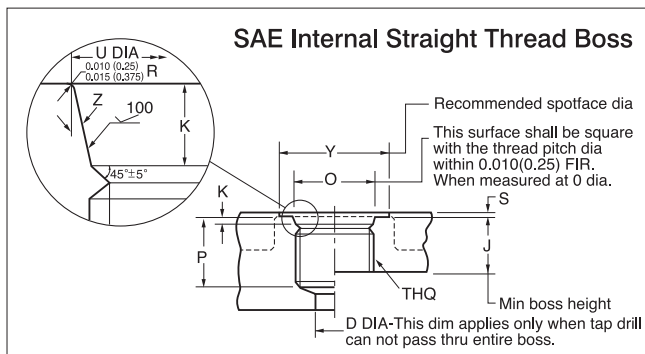

### Details of SAE Internal Straight Thread Boss

Unit:mm

Nom. Tube O.D.	Thread Size	D Min.	J Min.	K (±0.2)	O Min.	P <sup>d</sup> Min.	U <sup>a</sup> (+0.13/-0)	Y <sup>c</sup>	S <sup>bc</sup> Max	Z (±1°)
1/8	5/16-24	1.6	10.0	1.9	11	12.0	9.1	17	1.6	12°
3/16	3/8-24	3.2	10.0	1.9	13	12.0	10.7	19	1.6	12°
1/4	7/16-20	4.4	11.5	2.4	15	14.0	12.4	21	1.6	12°
5/16	1/2-20	6.0	11.5	2.4	16	14.0	14.0	23	1.6	12°
3/8	9/16-18	7.5	12.7	2.5	18	15.5	15.6	25	1.6	12°
1/2	3/4-16	10.0	14.3	2.5	22	17.5	20.6	30	2.4	15°
5/8	7/8-14	12.5	16.7	2.5	26	20.0	23.9	34	2.4	15°
3/4	1-1/16-12	16.0	19.0	3.3	32	23.0	29.2	41	2.4	15°
7/8	1-3/16-12	18.0	19.0	3.3	35	23.0	32.3	45	2.4	15°
1	1-5/16-12	21.0	19.0	3.3	38	23.0	35.5	49	3.2	15°
1-1/4	1-5/8-12	27.0	19.0	3.3	48	23.0	43.5	58	3.2	15°
1-1/2	1-7/8-12	33.0	19.0	3.3	54	23.0	49.8	65	3.2	15°
2	2-1/2-12	70.0	19.0	3.3	70	23.0	65.7	88	3.2	15°

- a. Diameter U shall be concentric with the thread pitch diameter within 0.13 full indicator reading (FIR) and shall be free from longitudinal and spiral tool marks. Annular tool marks up to 2.5 micro meters max. shall be permissible.
- b. This is the maximum recommended spotface depth to permit sufficient wrench grip for the proper tightening of the fitting or locknut.
- c. If the face of the boss is on a machined surface, dimensions Y and S need not apply as long as R 0.25/ 0.375 is maintained to avoid damage to the O-Ring during installation.
- d. Tap drill depths given require the use of bottoming taps to produce the specified full thread lengths. Where standard taps are used, the tap drill depths must be increased accordingly.

### O-Ring and straight thread size for SAE Fittings Bosses

Nominal Tube O.D.	Port Size	Thread Size	O-Ring		
			Size No.	I.D. inch	Cross Section inch
1/8	2	5/16-24	902	0.239	0.064
3/16	3	3/8-24	903	0.301	0.064
1/4	4	7/16-20	904	0.351	0.072
5/16	5	1/2-20	905	0.414	0.072
3/8	6	9/16-18	906	0.468	0.078
1/2	8	3/4-16	908	0.644	0.087
5/8	10	7/8-14	910	0.755	0.097
3/4	12	1-1/16-12	912	0.924	0.116
7/8	14	1-3/16-12	914	1.048	0.116
1	16	1-5/16-12	916	1.171	0.116
1-1/4	20	1-5/8-12	920	1.475	0.118
1-1/2	24	1-7/8-12	924	1.720	0.118
2	32	2-1/2-12	932	2.337	0.118

### Installation Instruction

- Step 1. Ensure the locknut is fully raised.
- Step 2. Lubricate the O-Ring with a light oil or petroleum and turn the fitting into the straight thread boss until the metal washer is in contact with the boss.
- Step 3. Position the fitting by backing it out (not more than 1turn counter-clockwise)until the S-LOK fitting is oriented in the desired direction.
- Step 4. With a back up wrench, hold the wrench pad and tighten the locknut until the washer is set against the face of the boss.



SAE Male Connector  
**SMCS**

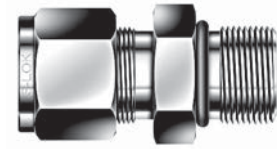
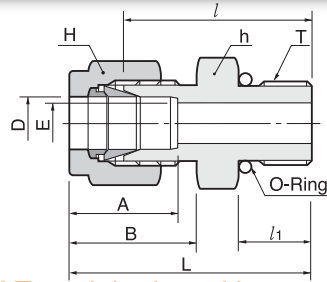

Connects fractional tube to SAE straight thread boss

Part No.	Tube O.D. D		Straight Thread T(u)	E Min.	Width across flat				A	B	l	l <sub>1</sub>	L	O-Ring Uniform Size Number
	in	mm			h	H	mm	in						
SMCS-2-2U	1/8	3.17	5/16-24	2.28	7/16	11.11	7/16	11.11	12.70	15.24	23.26	7.62	29.97	-902
SMCS-4-4U	1/4	6.35	7/16-20	4.82	9/16	14.28	9/16	14.28	15.24	17.78	26.67	9.14	34.03	-904
SMCS-4-6U	1/4	6.35	9/16-18	4.82	11/16	17.46	9/16	14.28	15.24	17.78	28.19	9.90	35.56	-906
SMCS-4-8U	1/4	6.35	3/4-16	4.82	7/8	22.22	9/16	14.28	15.24	17.78	30.22	11.17	37.59	-908
SMCS-4-10U	1/4	6.35	7/8-14	4.82	1	25.40	9/16	14.28	15.24	17.78	33.27	12.70	40.64	-910
SMCS-5-5U	5/16	7.93	1/2-20	5.84	5/8	15.87	5/8	15.87	16.25	18.54	27.43	9.14	34.79	-905
SMCS-6-4U	3/8	9.52	7/16-20	5.08	5/8	15.87	11/16	17.46	16.76	19.30	28.19	9.14	35.56	-904
SMCS-6-6U	3/8	9.52	9/16-18	7.11	11/16	17.46	11/16	17.46	16.76	19.30	29.71	9.90	37.08	-906
SMCS-6-8U	3/8	9.52	3/4-16	7.11	7/8	22.22	11/16	17.46	16.76	19.30	31.75	11.17	39.11	-908
SMCS-6-10U	3/8	9.52	7/8-14	7.11	1	25.40	11/16	17.46	16.76	19.30	34.79	12.70	42.16	-910
SMCS-8-6U	1/2	12.70	9/16-18	7.11	13/16	20.64	7/8	22.22	22.86	21.84	28.95	9.90	39.11	-906
SMCS-8-8U	1/2	12.70	3/4-16	10.41	7/8	22.22	7/8	22.22	22.86	21.84	31.75	11.17	41.91	-908
SMCS-8-10U	1/2	12.70	7/8-14	10.41	1	25.40	7/8	22.22	22.86	21.84	34.79	12.70	44.95	-910
SMCS-8-12U	1/2	12.70	1-1/16-12	10.41	1-1/4	31.75	7/8	22.22	22.86	21.84	38.86	14.98	49.02	-912
SMCS-10-8U	5/8	15.87	3/4-16	10.66	15/16	23.81	1	25.40	24.38	21.84	31.75	11.17	41.91	-908
SMCS-10-10U	5/8	15.87	7/8-14	12.70	1	25.40	1	25.40	24.38	21.84	35.05	12.70	45.21	-910
SMCS-12-8U	3/4	19.05	3/4-16	10.66	1-1/16	26.98	1-1/8	28.57	24.38	21.84	35.81	11.17	45.97	-908
SMCS-12-12U	3/4	19.05	1-1/16-12	15.74	1-1/4	31.75	1-1/8	28.57	24.38	21.84	38.86	14.98	49.02	-912
SMCS-14-14U	7/8	22.22	1-3/16-12	18.28	1-3/8	34.92	1-1/4	31.75	25.90	21.84	38.86	14.98	49.02	-914
SMCS-16-12U	1	25.40	1-1/16-12	16.76	1-3/8	34.92	1-1/2	38.10	31.24	26.41	41.14	14.98	53.34	-912
SMCS-16-16U	1	25.40	1-5/16-12	22.35	1-1/2	38.10	1-1/2	38.10	31.24	26.41	42.16	14.98	54.35	-916
SMCS-20-20U	1-1/4	31.75	1-5/8-12	27.68	1-7/8	47.63	1-7/8	47.63	41.14	38.86	46.22	14.98	68.32	-920
SMCS-24-24U	1-1/2	38.10	1-7/8-12	34.03	2-1/8	53.98	2-1/4	57.15	50.03	45.21	50.54	14.98	77.72	-924
SMCS-32-32U	2	50.80	2-1/2-12	45.97	2-3/4	69.85	3	76.20	67.56	62.73	64.26	14.98	101.60	-932

Positionable  
SAE Male Elbow  
**SLS**

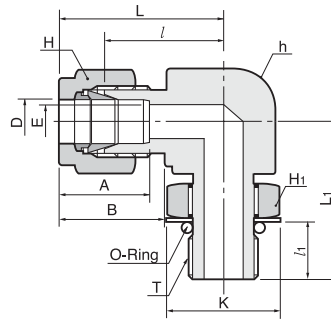

Connects fractional tube to SAE straight thread boss

Part No.	Tube O.D. D		Straight Thread T(u)	E Min.	Width across flat						A	B	l	l <sub>1</sub>	L	L <sub>1</sub>	K	O-Ring Uniform Size Number
	in	mm			h	H	H <sub>1</sub>	mm	in	mm								
SLS-4-4U	1/4	6.35	7/16-20	4.82	1/2	12.70	9/16	14.28	9/16	14.28	15.24	17.78	21.08	9.90	28.44	28.44	16.51	-904
SLS-5-5U	5/16	7.93	1/2-20	5.84	9/16	14.28	5/8	15.87	5/8	15.87	16.25	18.54	22.86	9.90	30.22	29.46	18.28	-905
SLS-6-6U	3/8	9.52	9/16-18	7.11	5/8	15.87	11/16	17.46	11/16	17.46	16.76	19.30	24.63	11.17	32.00	32.25	20.06	-906
SLS-6-8U	3/8	9.52	3/4-16	7.11	13/16	20.64	11/16	17.46	7/8	22.22	16.76	19.30	27.43	12.70	34.79	37.84	25.65	-908
SLS-8-8U	1/2	12.70	3/4-16	10.41	13/16	20.64	7/8	22.22	7/8	22.22	22.86	21.84	27.43	12.70	37.59	37.84	25.65	-908
SLS-10-10U	5/8	15.87	7/8-14	12.70	1	25.40	1	25.40	1	25.40	24.38	21.84	29.46	14.22	39.62	43.43	29.46	-910
SLS-12-12U	3/4	19.05	1-1/16-12	15.74	1-1/16	26.98	1-1/8	28.57	1-1/4	31.75	24.38	21.84	31.24	16.76	41.40	48.76	36.57	-912
SLS-14-14U	7/8	22.22	1-3/16-12	18.28	1-1/4	31.75	1-1/4	31.75	1-3/8	34.92	25.90	21.84	33.02	16.76	43.18	50.54	40.38	-914
SLS-16-16U	1	25.40	1-5/16-12	22.35	1-3/8	34.92	1-1/2	38.10	1-1/2	38.10	31.24	26.41	38.35	16.76	50.54	53.59	43.94	-916
SLS-20-20U	1-1/4	31.75	1-5/8-12	27.68	1-11/16	42.76	1-7/8	47.63	1-7/8	47.63	41.14	38.86	45.72	16.76	67.81	58.16	54.86	-920
SLS-24-24U	1-1/2	38.10	1-7/8-12	34.03	2	50.80	2-1/4	57.15	2-1/8	53.98	50.03	45.21	50.80	16.76	77.97	60.45	62.23	-924
SLS-32-32U	2	50.80	2-1/2-12	45.97	2-3/4	69.85	3	76.20	2-3/4	69.85	67.56	62.73	69.85	16.76	107.18	71.62	80.26	-932

# S-LOK Tube Fittings

## Positionable 45° SAE Male Elbow SLBS

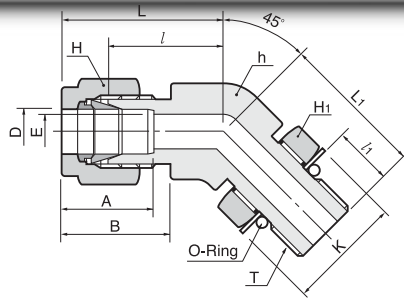

Connects fractional tube to SAE straight thread boss

Part No.	Tube O.D. D		Straight Thread T(u)	E Min.	Width across flat					A	B	l	l <sub>1</sub>	L	L <sub>1</sub>	K	O-Ring Uniform Size Number	
	in	mm			h	H	H <sub>1</sub>	in	mm									in
SLBS-4-4U	1/4	6.35	7/16-20	4.82	1/2	12.70	9/16	14.28	9/16	14.28	15.24	17.78	18.28	9.90	25.65	25.65	16.51	-904
SLBS-6-6U	3/8	9.52	9/16-18	7.11	5/8	15.87	11/16	17.46	11/16	17.46	16.76	19.30	20.57	11.17	27.94	28.19	20.06	-906
SLBS-8-8U	1/2	12.70	3/4-16	10.41	13/16	20.64	7/8	22.22	7/8	22.22	22.86	21.84	21.84	12.70	32.00	32.25	25.65	-908
SLBS-12-12U	3/4	19.05	1-1/16-12	15.74	1-1/8	28.58	1-1/8	28.58	1-1/4	31.75	24.38	21.84	29.71	16.76	39.87	47.24	36.57	-912
SLBS-16-16U	1	25.40	1-5/16-12	22.35	1-3/8	34.92	1-1/2	38.10	1-1/2	38.10	31.24	26.41	35.30	16.76	47.49	50.54	43.94	-916

## Positionable SAE Male Run Tee STRS

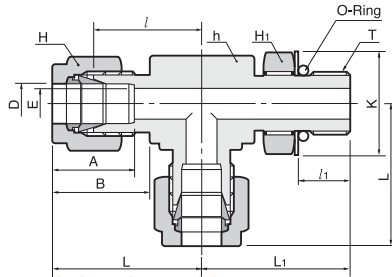

Connects fractional tube to SAE straight thread boss

Part No.	Tube O.D. D		Straight Thread T(u)	E Min.	Width across flat					A	B	l	l <sub>1</sub>	L	L <sub>1</sub>	K	O-Ring Uniform Size Number	
	in	mm			h	H	H <sub>1</sub>	in	mm									in
STRS-4-4U	1/4	6.35	7/16-20	4.82	1/2	12.70	9/16	14.28	9/16	14.28	15.24	17.78	21.08	9.90	28.44	28.44	16.51	-904
STRS-6-6U	3/8	9.52	9/16-18	7.11	5/8	15.87	11/16	17.46	11/16	17.46	16.76	19.30	24.63	11.17	32.00	32.25	20.06	-906
STRS-8-8U	1/2	12.70	3/4-16	10.41	13/16	20.64	7/8	22.22	7/8	22.22	22.86	21.84	27.43	12.70	37.59	37.84	25.65	-908
STRS-12-12U	3/4	19.05	1-1/16-12	15.74	1-1/8	26.98	1-1/8	28.58	1-1/4	31.75	24.38	21.84	31.24	16.76	41.40	48.76	36.57	-912
STRS-16-16U	1	25.40	1-5/16-12	22.35	1-3/8	34.92	1-1/2	38.10	1-1/2	38.10	31.24	26.41	38.35	16.76	50.54	50.54	43.94	-916
STRS-20-20U	1-1/4	31.75	1-5/8-12	27.68	1-11/16	42.86	1-7/8	47.63	1-7/8	47.63	41.14	38.86	45.72	16.76	67.81	58.16	54.86	-920
STRS-24-24U	1-1/2	38.10	1-7/8-12	34.03	2	50.80	2-1/4	57.15	2-1/8	53.98	50.03	45.21	50.80	16.76	77.97	60.45	62.23	-924
STRS-32-32U	2	50.80	2-1/2-12	45.97	2-3/4	69.85	3	76.20	2-3/4	69.85	67.56	62.73	69.85	16.76	107.18	71.62	80.26	-932

## Positionable SAE Male Branch Tee STBS

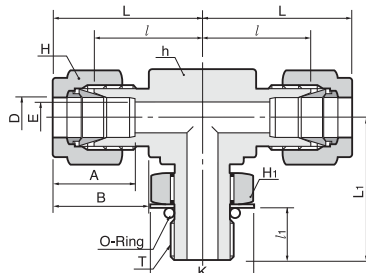

Connects fractional tube to SAE straight thread boss

Part No.	Tube O.D. D		Straight Thread T(u)	E Min.	Width across flat					A	B	l	l <sub>1</sub>	L	L <sub>1</sub>	K	O-Ring Uniform Size Number	
	in	mm			h	H	H <sub>1</sub>	in	mm									in
STBS-4-4U	1/4	6.35	7/16-20	4.82	1/2	12.70	9/16	14.28	9/16	14.28	15.24	17.78	21.08	9.90	28.44	28.44	16.51	-904
STBS-6-6U	3/8	9.52	9/16-18	7.11	5/8	15.87	11/16	17.46	11/16	17.46	16.76	19.30	24.63	11.17	32.00	32.25	20.06	-906
STBS-8-8U	1/2	12.70	3/4-16	10.41	13/16	20.64	7/8	22.22	7/8	22.22	22.86	21.84	27.43	12.70	37.59	37.84	25.65	-908
STBS-12-12U	3/4	19.05	1-1/16-12	15.74	1-1/16	26.98	1-1/8	28.58	1-1/4	31.75	24.38	21.84	31.24	16.76	41.40	48.76	36.57	-912
STBS-16-16U	1	25.40	1-5/16-12	22.35	1-3/8	34.92	1-1/2	38.10	1-1/2	38.10	31.24	26.41	38.35	16.76	50.54	53.59	43.94	-916
STBS-20-20U	1-1/4	31.75	1-5/8-12	27.68	1-11/16	42.86	1-7/8	47.63	1-7/8	47.63	41.14	38.86	45.72	16.76	67.81	58.16	54.86	-920
STBS-24-24U	1-1/2	38.10	1-7/8-12	34.03	2	50.80	2-1/4	57.15	2-1/8	53.98	50.03	45.21	50.80	16.76	77.97	60.45	62.23	-924
STBS-32-32U	2	50.80	2-1/2-12	45.97	2-3/4	69.85	3	76.20	2-3/4	69.85	67.56	62.73	69.85	16.76	107.18	71.62	80.26	-932

## O-Seal Connector

S-LOK O-ring seal fittings provide leak-tight sealing on both vacuum and high pressure with a smooth & flat surface perpendicular to the threaded port to ensure metal to metal contact.

The standard Buna N O-ring is contained in a precision groove to prevent O-ring extrusion at high pressure and for a controlled squeeze in a vacuum service.

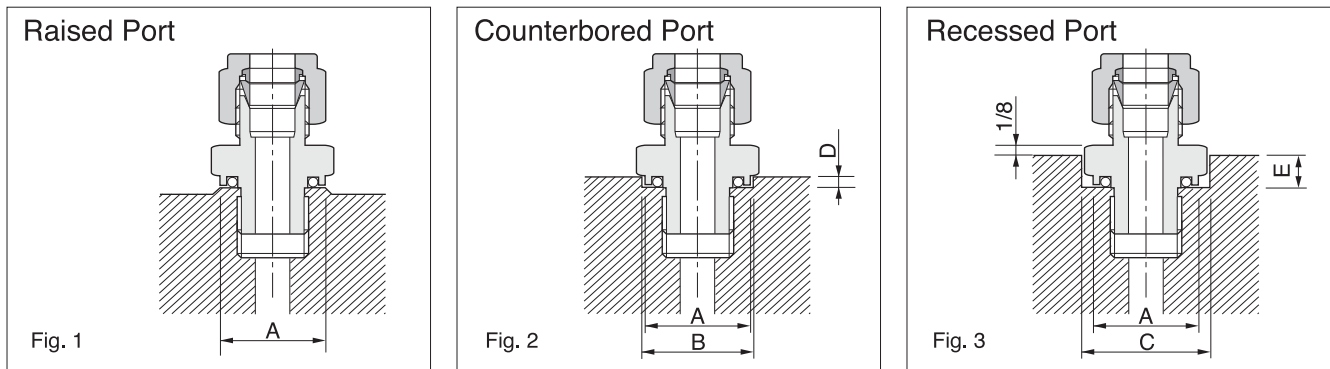

### Mounting Dimensions for O-seal connectors

Saehan-LOK Part No.	Straight Thread	Pipe Thread	Diameter						Depth			
			A		B		C		D		E	
			Min.		Min.		Min.		Max.		Max.	
			Inch	mm	Inch	mm	Inch	mm	Inch	mm	Inch	mm
SCOS-2-2U	5/16-24	-	0.50	12.7	0.59	15.0	0.66	16.8	0.09	2.3	0.16	5.6
SCOS-3-3U	3/8-24	-	0.56	14.2	0.66	16.8	0.75	19.1	0.09	2.3	0.22	5.6
SCOS-4-4U	7/16-20	-	0.69	17.5	0.78	19.8	0.88	22.4	0.16	4.1	0.28	7.1
SCOS-5-5U	1/2-20	-	0.75	19.1	0.91	23.1	1.03	26.2	0.16	4.1	0.31	7.9
SCOS-6-6U	9/16-18	-	0.81	20.6	0.97	24.6	1.09	27.7	0.16	4.1	0.31	7.9
SCOS-8-8U	3/4-16	-	1.00	25.4	1.16	29.5	1.31	33.3	0.16	4.1	0.34	8.6
SCOS-12-12U	1-1/16-12	-	1.41	35.8	1.53	38.9	1.75	44.5	0.22	5.6	0.50	12.7
SCOS-16-16U	1-5/16-12	-	1.69	42.9	1.78	45.2	2.03	51.6	0.22	5.6	0.56	14.2
SCOP-2-2	-	1/8 NPT	0.69	17.5	0.78	19.8	0.88	22.4	0.16	4.1	0.28	7.1
SCOP-4-2	-	1/8 NPT	0.69	17.5	0.78	19.8	0.88	22.4	0.16	4.1	0.28	7.1
SCOP-4-4	-	1/4 NPT	0.87	22.1	0.97	24.6	1.09	27.7	0.16	4.1	0.31	7.9
SCOP-6-6	-	3/8 NPT	1.00	25.4	1.16	29.5	1.31	33.3	0.16	4.1	0.34	8.6
SCOP-6-8	-	1/2 NPT	1.22	31.0	1.34	34.0	1.53	38.9	0.22	5.6	0.44	11.2
SCOP-8-8	-	1/2 NPT	1.22	31.0	1.34	34.0	1.53	38.9	0.22	5.6	0.44	11.2

### When installing an O-ring seal fitting:

1. Hand-tighten it until the squeeze on the O-ring can be felt during the last 1/4 turn
2. Snug the fitting lightly with a wrench

### When connecting & disconnecting the tubing to the O-ring fitting:

1. Use a back-up wrench on the fitting hex so it does not turn while the nut is being tightened at the tubing connection.
2. When disconnecting the tubing also use a back-up wrench so the fitting does not turn
3. For a recessed port, use a thin back-up wrench (1/8") to hold the fitting hex (Fig. 3).

# S-LOK Tube Fittings

## O-Seal Straight Thread Connector SCOS

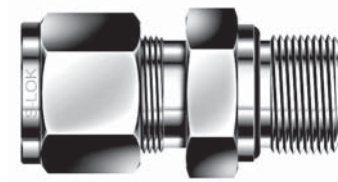
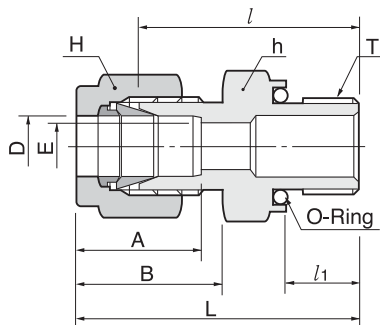

Connects fractional tube to female straight thread

Part No.	Tube O.D. D		Straight Thread T(u)	E Min.	Width across flat				A	B	l	l <sub>1</sub>	L	O-Ring Uniform Size Number
	in	mm			h	mm	in	H						
SCOS-2 - 2U	1/8	3.17	5/16-20	2.28	9/16	14.28	7/16	11.11	12.70	15.24	26.16	8.63	32.76	-011
SCOS-3 - 3U	3/16	4.76	3/8-24	3.04	5/8	15.87	1/2	12.70	13.71	16.00	27.68	9.65	34.29	-012
SCOS-4 - 4U	1/4	6.35	7/16-20	4.82	3/4	19.05	9/16	14.28	15.24	17.78	30.98	10.41	38.35	-111
SCOS-5 - 5U	5/16	7.93	1/2-20	6.35	7/8	22.22	5/8	15.87	16.25	18.54	33.27	11.17	40.64	-112
SCOS-6 - 6U	3/8	9.52	9/16-18	7.11	15/16	23.81	11/16	17.46	16.76	19.30	35.05	11.93	42.41	-113
SCOS-8 - 8U	1/2	12.70	3/4-16	10.41	1-1/8	28.57	7/8	22.22	22.86	21.84	35.81	11.93	45.97	-116
SCOS-12 - 12U	3/4	19.05	1-1/16-12	15.74	1-1/2	38.10	1-1/8	28.58	24.38	21.84	42.16	14.22	52.32	-215
SCOS-16 - 16U	1	25.40	1-5/16-12	22.35	1-3/4	44.45	1-1/2	38.10	31.24	26.41	45.97	14.22	58.16	-219

## O-Seal Pipe Thread Connector SCOP

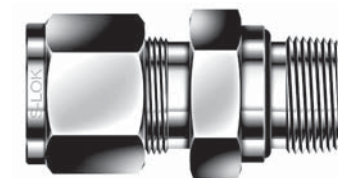
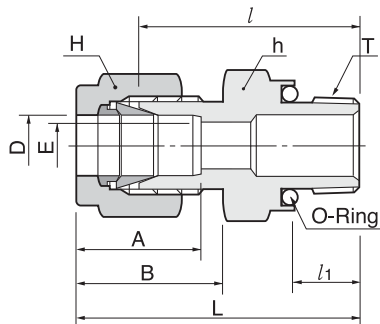

Connects fractional tube to female NPT thread

Part No.	Tube O.D. D		T *(NPT)	E Min.	Width across flat				A	B	l	l <sub>1</sub>	L	O-Ring Uniform Size Number
	in	mm			h	mm	in	H						
SCOP-2 - 2N	1/8	3.17	1/8	2.28	3/4	19.05	7/16	11.11	12.70	15.24	26.16	7.11	32.76	-111
SCOP-4 - 2N	1/4	6.35	1/8	4.82	3/4	19.05	9/16	14.28	15.24	17.78	27.68	7.11	35.05	-111
SCOP-4 - 4N	1/4	6.35	1/4	4.82	15/16	23.81	9/16	14.28	15.24	17.78	30.98	9.65	38.35	-113
SCOP-6 - 4N	3/8	9.52	1/4	7.11	15/16	23.81	11/16	17.46	16.76	19.30	32.51	9.65	39.87	-113
SCOP-6 - 6N	3/8	9.52	3/8	7.11	1-1/8	28.58	11/16	17.46	16.76	19.30	34.03	10.41	41.40	-116
SCOP-6 - 8N	3/8	9.52	1/2	7.11	1-5/16	33.33	11/16	17.46	16.76	19.30	39.62	13.46	46.99	-212
SCOP-8 - 8N	1/2	12.70	1/2	10.41	1-5/16	33.33	7/8	22.22	22.86	21.84	39.62	13.46	49.78	-212

\*ISO Paralled Threads are available upon request.

Male Pipe  
Weld Connector  
**SCW**

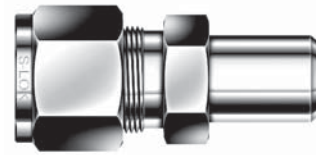
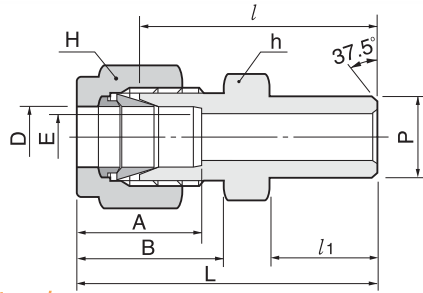

Connects fractional tube to pipe

Part No.	Tube O.D. D		Male Pipe Size P		E Min.	Width across flat				A	B	l	l1	L
	in	mm	Nom.	O. D.		h	H	in	mm					
SCW-2-2P	1/8	3.17	1/8	10.29	2.28	7/16	11.11	7/16	11.11	12.70	15.24	23.87	9.65	31.24
SCW-3-2P	3/16	4.76	1/8	10.29	3.04	7/16	11.11	1/2	12.70	13.71	16.00	24.63	9.65	31.24
SCW-4-2P	1/4	6.35	1/8	10.29	4.82	1/2	12.70	9/16	14.28	15.24	17.78	25.40	9.65	32.76
SCW-4-4P	1/4	6.35	1/4	13.72	4.82	9/16	14.28	9/16	14.28	15.24	17.78	30.48	14.22	37.84
SCW-5-2P	5/16	7.93	1/8	10.29	5.08	9/16	14.28	5/8	15.87	16.25	18.54	26.67	9.65	34.03
SCW-5-4P	5/16	7.93	1/4	13.72	6.35	9/16	14.28	5/8	15.87	16.25	18.54	31.24	14.22	38.60
SCW-6-4P	3/8	9.52	1/4	13.72	7.11	5/8	15.87	11/16	17.46	16.76	19.30	32.51	14.22	39.87
SCW-6-6P	3/8	9.52	3/8	17.15	7.11	11/16	17.46	11/16	17.46	16.76	19.30	32.51	14.22	39.87
SCW-6-8P	3/8	9.52	1/2	21.34	7.11	7/8	22.22	11/16	17.46	16.76	19.30	38.86	19.05	46.33
SCW-8-6P	1/2	12.70	3/8	17.15	10.41	13/16	20.64	7/8	22.22	22.86	21.84	33.27	14.22	43.43
SCW-8-8P	1/2	12.70	1/2	21.34	10.41	7/8	22.22	7/8	22.22	22.86	21.84	38.86	19.05	49.02
SCW-8-12P	1/2	12.70	3/4	26.67	10.41	1-1/16	26.98	7/8	22.22	22.86	21.84	40.38	19.05	50.54
SCW-10-8P	5/8	15.87	1/2	21.34	12.70	15/16	23.81	1	25.40	24.38	21.84	38.86	19.05	49.02
SCW-12-12P	3/4	19.05	3/4	26.67	15.74	1-1/16	26.98	1-1/8	28.58	24.38	21.84	40.38	19.05	50.54
SCW-16-16P	1	25.40	1	33.40	22.35	1-3/8	34.92	1-1/2	38.10	31.24	26.41	50.03	23.87	62.23
SCW-20-20P	1-1/4	31.75	1-1/4	42.16	27.68	1-3/4	44.45	2	50.80	41.14	38.86	55.11	23.87	77.21
SCW-24-24P	1-1/2	38.10	1-1/2	48.26	34.03	2-1/8	53.98	2-1/4	57.15	50.03	45.21	61.72	26.16	88.90
SCW-32-32P	2	50.80	2	60.33	47.75	2-3/4	69.85	3	76.20	67.56	62.73	76.20	26.92	113.53

Connects metric tube to pipe

Part No.	Tube O.D. D		Male Pipe Size P		E Min.	Width across flat		A	B	l	l1	L
	in	mm	Nom.	O. D.		h	H					
SCW-3M-2P	3	1/8	10.29	2.4	12	12	12.9	15.3	23.1	9.7	29.7	
SCW-4M-2P	4	1/8	10.29	2.4	12	12	13.7	16.1	24.1	9.7	30.7	
SCW-6M-2P	6	1/8	10.29	4.8	14	14	15.3	17.7	25.4	9.7	32.8	
SCW-6M-4P	6	1/4	13.72	4.8	14	14	15.3	17.7	30.2	14.2	37.6	
SCW-8M-2P	8	1/8	10.29	5.1	15	16	16.2	18.6	26.7	9.7	34.2	
SCW-8M-4P	8	1/4	13.72	6.4	15	16	16.2	18.6	31.2	14.2	38.7	
SCW-8M-8P	8	1/2	21.34	6.4	22	16	16.2	18.6	37.3	19.0	44.8	
SCW-10M-4P	10	1/4	13.72	7.1	18	19	17.2	19.5	33.3	14.2	40.9	
SCW-10M-6P	10	3/8	17.15	7.9	18	19	17.2	19.5	32.5	14.2	40.1	
SCW-10M-8P	10	1/2	21.34	7.9	22	19	17.2	19.5	38.1	19.0	45.7	
SCW-12M-4P	12	1/4	13.72	7.1	22	22	22.8	22.0	33.3	14.2	43.4	
SCW-12M-6P	12	3/8	17.15	9.5	22	22	22.8	22.0	33.3	14.2	43.4	
SCW-12M-8P	12	1/2	21.34	9.5	22	22	22.8	22.0	38.1	19.0	48.2	
SCW-14M-6P	14	3/8	17.15	10.3	24	25	24.4	22.0	34.0	14.2	44.1	
SCW-15M-8P	15	1/2	21.34	11.9	24	25	24.4	22.0	38.9	19.0	49.0	
SCW-16M-8P	16	1/2	21.34	12.7	24	25	24.4	22.0	38.9	19.0	49.0	
SCW-18M-8P	18	1/2	21.34	13.5	27	30	24.4	22.0	40.4	19.0	50.5	
SCW-32M-20P	32	1-1/4	42.16	28.6	46	50	42.0	41.6	56.6	23.9	79.6	
SCW-38M-24P	38	1-1/2	48.26	33.7	55	60	49.4	47.9	64.0	26.2	91.6	

**S-LOK Welding information**

S-LOK weld ends are constructed to Schedule 80 wall or greater.

The first step is to remove the nut and ferrules from the S-LOK fitting to protect them from weld heat and cover the threads with a protective device (i.e. another nut or a plug) SP to protect the S-LOK port threads & sealing surface from weld spatter. Only finger-tighten the protective device so that you can use it many times.

The second step is to tack weld at four positions 90° apart to hold the fitting in place to ensure alignment and concentricity of the components, then complete the weld.

# S-LOK Tube Fittings

## Male Pipe Weld Elbow SLW

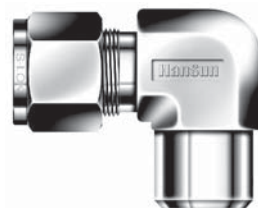
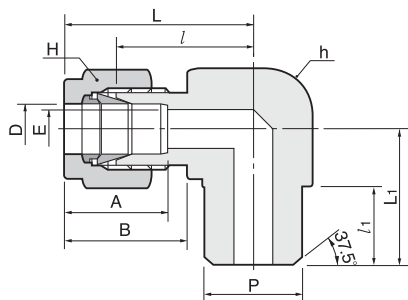

Connects fractional tube to pipe

Part No.	Tube O.D.		Male Pipe Size		E Min.	Width across flat				A	B	l	l <sub>1</sub>	L	L <sub>1</sub>
	D		P			h		H							
	in	mm	Nom.	O. D.		in	mm	in	mm						
LW-2-2P	1/8	3.17	1/8	10.29	4.82	1/2	12.70	9/16	14.28	15.24	17.78	19.55	9.65	26.92	18.79
LW-4-4P	1/4	6.35	1/4	13.72	4.82	1/2	12.70	9/16	14.28	15.24	17.78	19.55	14.22	26.92	23.36
LW-6-4P	3/8	9.52	1/4	13.72	7.11	5/8	15.87	11/16	17.46	16.76	19.30	23.11	14.22	30.48	25.40
LW-8-8P	1/2	12.70	1/2	21.34	10.41	13/16	20.64	7/8	22.22	22.86	21.84	25.90	19.05	36.06	33.02
LW-12-12P	3/4	19.05	3/4	26.67	15.74	1-1/16	26.98	1-1/8	28.58	24.38	21.84	29.71	19.05	39.87	36.83

## Tube Socket Weld Connector SCSW

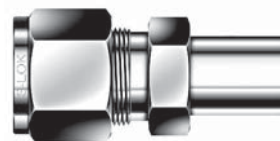
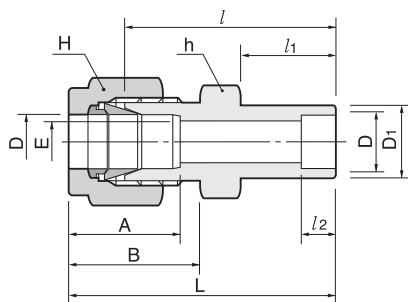

Connects fractional tubes

Part No.	Tube O. D.		E Min.	D <sub>1</sub>	Width across flat				A	B	l	l <sub>1</sub>	l <sub>2</sub>	L
	D				h		H							
	in	mm			in	mm	in	mm						
SCSW-2-2	1/8	3.17	2.28	7.87	7/16	11.11	7/16	11.11	12.70	15.24	22.35	8.63	6.35	28.95
SCSW-4-4	1/4	6.35	4.82	11.17	1/2	12.70	9/16	14.28	15.24	17.78	26.16	10.41	7.87	33.52
SCSW-6-6	3/8	9.52	7.11	15.74	5/8	15.87	11/16	17.46	16.76	19.30	30.22	11.93	9.65	37.59
SCSW-8-8	1/2	12.70	10.41	19.05	13/16	20.64	7/8	22.22	22.86	21.84	30.98	11.93	12.70	41.14
SCSW-12-12	3/4	19.05	15.74	26.67	1-1/16	26.98	1-1/8	28.58	24.38	21.84	33.27	11.93	14.22	43.43
SCSW-16-16	1	25.40	22.35	33.27	1-3/8	34.92	1-1/2	38.10	31.24	26.41	40.38	14.22	19.05	52.57

## Tube Socket Weld Elbow SLSW

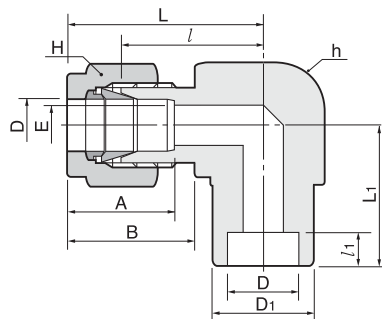

Connects fractional tubes

Part No.	Tube O. D.		E Min.	D <sub>1</sub>	Width across flat				A	B	l	l <sub>1</sub>	L	L <sub>1</sub>
	D				h		H							
	in	mm			in	mm	in	mm						
SLSW-4-4	1/4	6.35	4.82	12.70	1/2	12.70	9/16	14.28	15.24	17.78	19.55	7.87	26.92	19.55
SLSW-6-6	3/8	9.52	7.11	15.74	5/8	15.87	11/16	17.46	16.76	19.30	23.11	9.65	30.48	23.11
SLSW-8-8	1/2	12.70	10.41	20.57	13/16	20.64	7/8	22.22	22.86	21.84	25.90	12.70	36.06	25.90
SLSW-12-12	3/4	19.05	15.74	26.92	1-1/16	26.98	1-1/8	28.58	24.38	21.84	29.71	14.22	39.87	29.71
SLSW-16-16	1	25.40	22.35	35.05	1-3/8	34.93	1-1/2	38.10	31.24	26.41	36.83	19.05	49.02	36.83

Welding  
Bulkhead Union  
**SBUW**

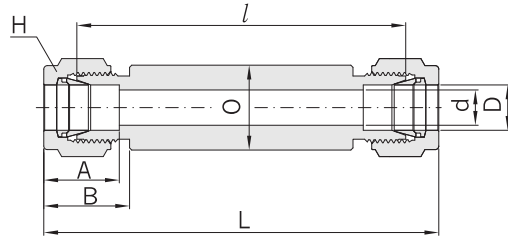

Connects fractional Tubes

Part No.	Tube O.D. D		d min	H		A	B	l	L	O
	in	mm		in	mm					
SBUW-1	1/16	1.59	1.27	5/16	7.93	8.63	10.92	64.2	71.85	10
SBUW-2	1/8	3.17	2.28	7/16	11.11	12.7	15.24	67.2	80.41	12
SBUW-3	3/16	4.76	3.04	7/16	11.11	13.71	16	69	82.2	12
SBUW-4	1/4	6.35	4.82	1/2	12.7	15.24	17.78	70.4	85.13	14
SBUW-5	5/16	7.93	6.35	9/16	14.28	16.25	18.54	73.7	88.43	16
SBUW-6	3/8	9.52	7.11	5/8	15.87	16.76	19.3	73.7	88.43	19
SBUW-8	1/2	12.7	10.41	13/16	20.64	22.86	21.84	73.7	94.02	23
SBUW-10	5/8	15.87	12.7	15/16	23.81	24.38	21.84	73.7	94.02	28
SBUW-12	3/4	19.05	15.74	11/16	26.98	24.38	21.84	73.7	94.02	32
SBUW-14	7/8	22.22	18.28	13/16	30.16	25.9	21.84	73.7	94.02	32
SBUW-16	1	25.4	22.35	13/8	34.92	31.24	26.41	78.5	102.89	35
SBUW-20	1-1/4	31.75	27.68	13/4	44.45	41.14	38.86	83.9	128.1	50
SBUW-24	1-1/2	38.1	34.03	21/8	53.97	50.03	45.21	86.1	140.45	55
SBUW-32	2	50.8	45.97	23/4	69.85	67.56	62.73	100.9	175.55	80

Connects Metric Tubes

Part No.	Tube O.D. D	d min	H	A	B	l	L	O
SBUW-2M	2	1.7	12	12.9	15.3	67.3	80.5	12
SBUW-3M	3	2.4	12	12.9	15.3	67.3	80.5	12
SBUW-4M	4	2.4	12	13.7	16.1	69	82.2	12
SBUW-6M	6	4.8	14	15.3	17.7	70.4	85.2	14
SBUW-8M	8	6.4	16	16.2	18.6	74	89	16
SBUW-10M	10	7.9	19	17.2	19.5	74	89.2	19
SBUW-12M	12	9.5	22	22.8	22	74	94.2	23
SBUW-15M	15	11.9	25	24.4	22	74	94.2	25
SBUW-16M	16	12.7	25	24.4	22	74	94.2	28
SBUW-18M	18	15.1	30	24.4	22	74	94.2	28
SBUW-20M	20	15.9	32	26	22	74	94.2	32
SBUW-22M	22	18.3	32	26	22	74	94.2	32
SBUW-25M	25	21.8	38	31.3	26.5	78.6	103.2	38
SBUW-28M	28	21.8	46	36.6	36.6	81.7	116.3	45
SBUW-30M	30	26.2	50	39.6	39.2	74	117.2	50
SBUW-32M	32	28.6	50	42	41.6	87.1	133.1	50
SBUW-38M	38	33.7	60	49.4	47.9	90.9	146.1	60
SBUW-42M	42	36.5	65	49.4	47.9	90.9	146.1	60

# S-LOK Tube Fittings

## Plug SP

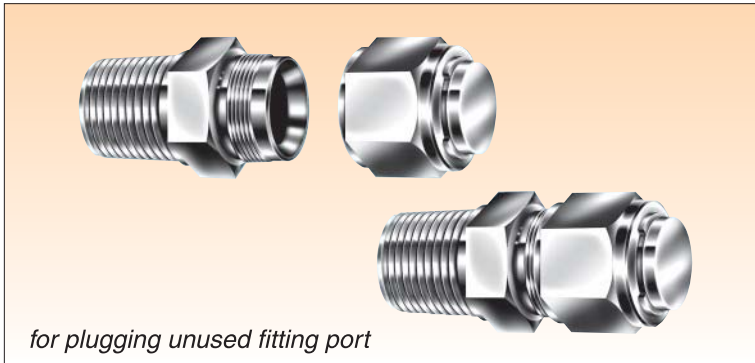
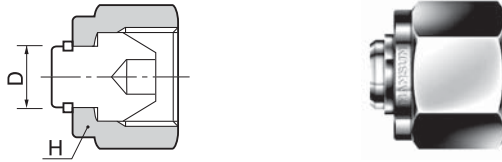

### Installation Instructions

1. Remove the nut and ferrules from the body
2. With a wrench, 1/4 turn from the finger-tight position, (1/8 turn for 1/8", 3/16" and 2mm, 3mm and 4mm)

### fractional

Part No.	Tube O.D. D		Width across flat H	
	in	mm	in	mm
SP-1	1/16	1.59	5/16	7.93
SP-2	1/8	3.17	7/16	11.11
SP-3	3/16	4.76	1/2	12.70
SP-4	1/4	6.35	9/16	14.28
SP-5	5/16	7.93	5/8	15.87
SP-6	3/8	9.52	11/16	17.46
SP-8	1/2	12.70	7/8	22.22
SP-10	5/8	15.87	1	25.40
SP-12	3/4	19.05	1-1/8	28.58
SP-14	7/8	22.22	1-1/4	31.75
SP-16	1	25.40	1-1/2	38.10
SP-20	1-1/4	31.75	1-7/8	47.63
SP-24	1-1/2	38.10	2-1/4	57.15
SP-32	2	50.80	3	76.20

### metric

Part No.	Tube O.D. D	Width across flat H	Part No.	Tube O.D. D	Width across flat H
SP-3M	3	12	SP-18M	18	30
SP-4M	4	12	SP-20M	20	32
SP-6M	6	14	SP-22M	22	32
SP-8M	8	16	SP-25M	25	38
SP-10M	10	19	SP-28M	28	46
SP-12M	12	22	SP-32M	32	50
SP-15M	15	25	SP-38M	38	60

### Cap end of fractional tube

Part No.	Tube O.D. D		Width across flat				A	B	l	L
	in	mm	h		H					
SC-1	1/16	1.59	5/16	7.93	5/16	7.93	8.63	10.92	11.20	14.18
SC-2	1/8	3.17	7/16	11.11	7/16	11.11	12.70	15.24	13.46	20.06
SC-3	3/16	4.76	7/16	11.11	1/2	12.70	13.71	16.00	14.73	21.33
SC-4	1/4	6.35	1/2	12.70	9/16	14.28	15.24	17.78	16.00	23.26
SC-5	5/16	7.93	9/16	14.28	5/8	15.87	16.25	18.54	17.01	24.38
SC-6	3/8	9.52	5/8	15.87	11/16	17.46	16.76	19.30	18.28	25.65
SC-8	1/2	12.70	13/16	20.63	7/8	22.22	22.86	21.84	19.05	29.21
SC-10	5/8	15.87	15/16	23.81	1	25.40	24.38	21.84	19.81	29.97
SC-12	3/4	19.05	1-1/16	26.98	1-1/8	28.57	24.38	21.84	21.33	31.49
SC-14	7/8	22.22	1-3/16	30.16	1-1/4	31.75	25.90	21.84	23.87	34.03
SC-16	1	25.40	1-3/8	34.92	1-1/2	38.10	31.24	26.41	26.16	38.35
SC-20	1-1/4	31.75	1-3/4	44.45	1-7/8	47.63	41.14	38.86	31.24	53.34
SC-24	1-1/2	38.10	2-1/8	53.98	2-1/4	57.15	50.15	45.21	37.33	64.51
SC-32	2	50.80	2-3/4	69.85	3	76.20	67.56	62.73	49.27	86.61

### Cap end of metric tube

Part No.	Tube O.D. D	Width across flat		A	B	l	L
		h	H				
SC-2M	2	12	12	12.9	15.3	13.5	20.1
SC-3M	3	12	12	12.9	15.3	13.5	20.1
SC-4M	4	12	12	13.7	16.1	14.7	21.3
SC-6M	6	14	14	15.3	17.7	15.7	23.1
SC-8M	8	15	16	16.2	18.6	17.0	24.5
SC-10M	10	18	19	17.2	19.5	19.0	26.6
SC-12M	12	22	22	22.8	22.0	19.0	29.1
SC-15M	15	24	25	24.4	22.0	19.8	29.9
SC-16M	16	24	25	24.4	22.0	19.8	29.9
SC-18M	18	27	30	24.4	22.0	21.3	31.4
SC-20M	20	30	32	26.0	22.0	23.9	34.0
SC-22M	22	30	32	26.0	22.0	23.9	34.0
SC-25M	25	35	38	31.3	26.5	26.2	38.5
SC-28M	28	41	46	36.6	36.6	27.7	48.5
SC-32M	32	46	50	42.0	41.6	32.8	55.8
SC-38M	38	55	60	49.4	47.9	37.8	65.4

## Cap SC

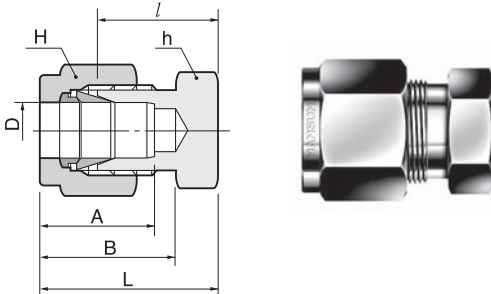

### Installation Instructions

1. Insert the tube end into the Cap
2. With a wrench, 1-1/4 turns from the finger-tight position, (3/4 turn for 1/8", 3/16" 3mm and 4mm)

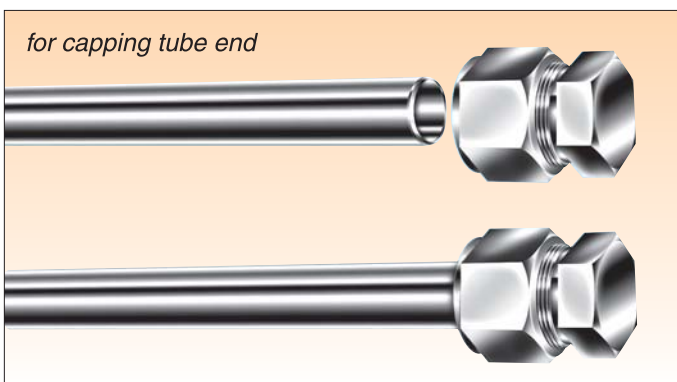



## Tube Insert SI

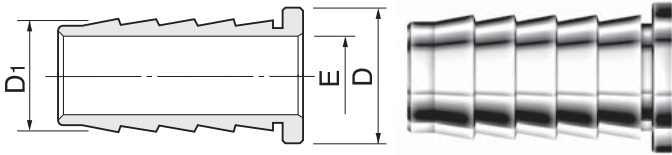

for Nylon or Soft Plastic Tubing

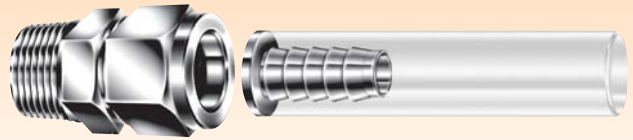

### fractional

Part No.	Tube O.D.				E
	D		D1		
	in	mm	in	mm	
SI-3-2	3/16	4.76	1/8	3.17	2.28
SI-4-2	1/4	6.35	1/8	3.17	2.28
SI-4-3	1/4	6.35	3/16	4.76	3.55
SI-5-2	5/16	7.93	1/8	3.17	2.28
SI-5-3	5/16	7.93	3/16	4.76	3.04
SI-5-4	5/16	7.93	1/4	6.35	4.82
SI-6-3	3/8	9.52	3/16	4.76	3.04
SI-6-4	3/8	9.52	1/4	6.35	4.82
SI-8-4	1/2	12.7	1/4	6.35	4.82
SI-8-6	1/2	12.7	3/8	9.52	7.87
SI-10-6	5/8	15.87	3/8	9.52	7.87
SI-10-8	5/8	15.87	1/2	12.70	11.17
SI-12-8	3/4	19.05	1/2	12.70	11.17
SI-12-10	3/4	19.05	5/8	15.87	14.22
SI-16-12	1	25.4	3/4	19.05	17.52

### Installation Instructions

The S-LOK Tube Insert supports the soft plastic tubing, thus the tubing does not collapse when the ferrules deform it. When you select a size of Tube Insert, check if the tubing O.D. and I. D. conform to those of the tube insert.

### metric

Part No.	Tube O.D.		E
	D	D1	
SI-6M-4M	6	4	2.8
SI-8M-6M	8	6	4.4
SI-10M-8M	10	8	6.4
SI-12M-8M	12	8	6.4
SI-12M-10M	12	10	8.3

## Nut SN

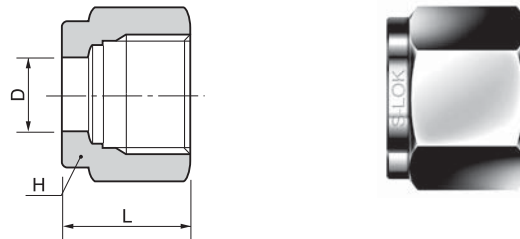

### fractional

Part No.	Tube O.D.		Width across flat		L
	D		H		
	in	mm	in	mm	
SN-1	1/16	1.59	5/16	7.93	7.90
SN-2	1/8	3.17	7/16	11.11	11.93
SN-3	3/16	4.76	1/2	12.70	11.93
SN-4	1/4	6.35	9/16	14.28	12.70
SN-5	5/16	7.93	5/8	15.87	13.46
SN-6	3/8	9.52	11/16	17.46	14.22
SN-8	1/2	12.70	7/8	22.22	17.52
SN-10	5/8	15.87	1	25.40	17.52
SN-12	3/4	19.05	1-1/8	28.57	17.52
SN-14	7/8	22.22	1-1/4	31.75	17.52
SN-16	1	25.40	1-1/2	38.10	20.57
SN-20	1-1/4	31.75	1-7/8	47.63	31.75
SN-24	1-1/2	38.10	2-1/4	57.15	38.10
SN-32	2	50.80	3	76.20	52.32

### metric

Part No.	Tube O.D.		Width across flat		L
	D	H	H	L	
SN - 2M	2	12	12	11.90	
SN - 3M	3	12	12	11.90	
SN - 4M	4	12	12	11.90	
SN - 6M	6	14	14	12.70	
SN - 8M	8	16	16	13.50	
SN - 10M	10	19	19	15.10	
SN - 12M	12	22	22	17.40	
SN - 15M	15	25	25	17.40	
SN - 16M	16	25	25	17.40	
SN - 18M	18	30	30	17.40	
SN - 20M	20	32	32	17.40	
SN - 22M	22	32	32	17.40	
SN - 25M	25	38	38	20.60	
SN - 28M	28	46	46	30.60	
SN - 32M	32	50	50	34.40	
SN - 38M	38	60	60	40.60	

# S-LOK Tube Fittings

## Front Ferrule SFF

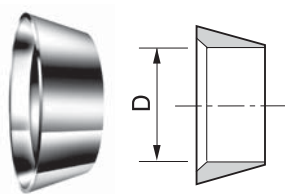

### fractional

Part No.	Tube O.D. D	
	in	mm
SFF-1	1/16	1.59
SFF-2	1/8	3.17
SFF-3	3/16	4.76
SFF-4	1/4	6.35
SFF-5	5/16	7.93
SFF-6	3/8	9.52
SFF-8	1/2	12.70
SFF-10	5/8	15.87
SFF-12	3/4	19.05
SFF-14	7/8	22.22
SFF-16	1	25.40
SFF-20	1-1/4	31.75
SFF-24	1-1/2	38.10
SFF-32	2	50.80

### metric

Part No.	Tube O.D. D
	SFF-2M
SFF-3M	3
SFF-4M	4
SFF-6M	6
SFF-8M	8
SFF-10M	10
SFF-12M	12
SFF-15M	15
SFF-16M	16
SFF-18M	18
SFF-20M	20
SFF-22M	22
SFF-25M	25
SFF-28M	28
SFF-32M	32
SFF-38M	38

## Back Ferrule SFB

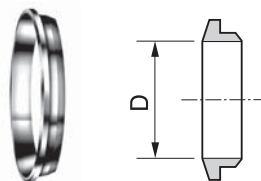

### fractional

Part No.	Tube O.D. D	
	in	mm
SFB-1	1/16	1.59
SFB-2	1/8	3.17
SFB-3	3/16	4.76
SFB-4	1/4	6.35
SFB-5	5/16	7.93
SFB-6	3/8	9.52
SFB-8	1/2	12.70
SFB-10	5/8	15.87
SFB-12	3/4	19.05
SFB-14	7/8	22.22
SFB-16	1	25.40
SFB-20	1-1/4	31.75
SFB-24	1-1/2	38.10
SFB-32	2	50.80

### metric

Part No.	Tube O.D. D
	SFB-2M
SFB-3M	3
SFB-4M	4
SFB-6M	6
SFB-8M	8
SFB-10M	10
SFB-12M	12
SFB-15M	15
SFB-16M	16
SFB-18M	18
SFB-20M	20
SFB-22M	22
SFB-25M	25
SFB-28M	28
SFB-32M	32
SFB-38M	38

## Ferrule Set SFS

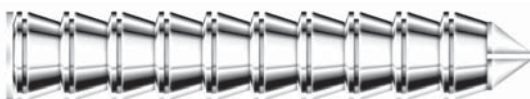

### fractional

Part No.	Tube O.D.	
	in	mm
SFS-1	1/16	1.59
SFS-2	1/8	3.17
SFS-3	3/16	4.76
SFS-4	1/4	6.35
SFS-5	5/16	7.93
SFS-6	3/8	9.52
SFS-8	1/2	12.70
SFS-10	5/8	15.87
SFS-12	3/4	19.05
SFS-14	7/8	22.22
SFS-16	1	25.40

### metric

Part No.	Tube O.D.
SFS-2M	2
SFS-3M	3
SFS-4M	4
SFS-6M	6
SFS-8M	8
SFS-10M	10
SFS-12M	12
SFS-15M	15
SFS-16M	16
SFS-18M	18
SFS-20M	20
SFS-22M	22
SFS-25M	25

## Gap Gauge for Pull-up Inspection SIG

S-LOK maintains unbelievably tight tolerance on its each and every part. S-LOK tube fittings are monitored and gauged throughout process. This assures S-LOK consistency and makes S-LOK fittings gaugable.

This no-go gauge is the useful tool to inspect if the fittings are pulled up 1-1/4 turns from the finger-tight position. When the gauge doesn't fit the gap between the nut and body hex, the fitting is tightened 1-1/4 turns from the finger-tight position. If the gauge fits the gap, the fittings is not fully tightened.

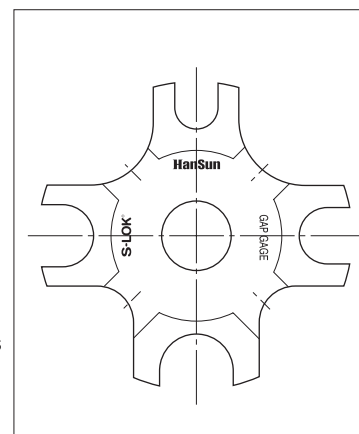

### Multiple Size Gap Gauge

Part No.	Applicable S-LOK Tube O.D.
SIG-468	1/4", 3/8", 1/2", 6mm, 10mm, 12mm

## SEAL & CONDENSATE POT

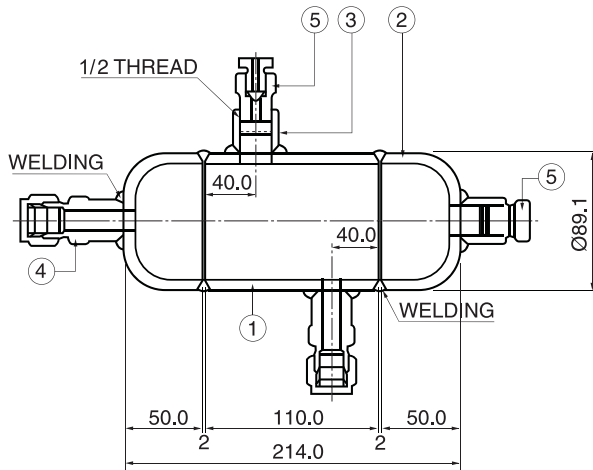

### End Connection Designator

CONNECTION	IDENTIFIER
1/2 NPT	N
1/2 PT	R
1/2 S.W	W
1/2 Shinil LOK	T

### Class Designator Of Fittings

SCHEDULE NO.	IDENTIFIER
SCH 40	A
SCH 80	B
SCH 160	C
SCH XXS	D

### Materials of Constructions

NO.	Description	Materials
①	3" Pipe	Refer to below
②	3" Cap	Refer to below
③	Half Coupling	SS316 or CS
④	Weld Connector	SS316
⑤	Vent Plug	SS316 or CS
⑥	Hex. Plug	SS316 or CS

### Shapes Designator

SHAPES	IDENTIFIER
	A
	B
	C
	D
	E
	F

### Materials Designator

MATERIALS	IDENTIFIER
A335 Gr P11	1
A335 Gr P22	2
A106 Gr B	3
A312 Gr TP304	4
A312 Gr TP316	5
A312 Gr TP304L	6
A312 Gr TP316L	7

## TANK SYPHON

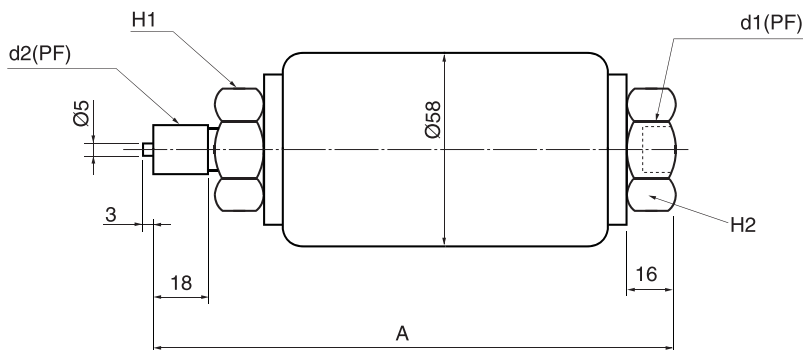

### SPECIFICATION

1. USING PRESSURE: 0-150kg<sup>2</sup>/cm
2. MAX. PRESSURE: 200kg<sup>2</sup>/cm
3. TANK CAPACITY: 80cc
4. FLUID TEMP: LESS THAN 350°C
5. WEIGHT: 1.8Kg

NO.	TYPE	MATERIAL	DIMENSION (mm)				
			d1, d2	A	B	H1	H2
TS2	TS10-333SSPF 3/8	SUS316	PF3/8	t61	18	32	32

Unit: mm



27 Noksansandan361-ro, Gangseo-gu  
(Songjeong-dong), Busan, Korea

Tel : +82-51-899-6700, Fax : +82-51-899-6799

E-Mail : [overseas@ehansun.co.kr](mailto:overseas@ehansun.co.kr)

[sales@ehansun.co.kr](mailto:sales@ehansun.co.kr)

Website : [www.ehansun.co.kr](http://www.ehansun.co.kr), [www.slok.co.kr](http://www.slok.co.kr)